



Apple Memory Guide

April 1998



Basic Navigation Within Service Source

Plug-Ins:



Find

Searches the current document only



Search

Searches across all Acrobat documents



Service Source Main Menu



Service Source Parts Database



Web Link

- Product Name
- ▷ BASICS
- ▷ SPECIFICATIONS
- ▷ TROUBLESHOOTING
- ▷ TAKE APART
- EXPLODED VIEW

When viewing Service Source Acrobat procedures with bookmarks active (the default setting), you can click a chapter title to go directly to that chapter. You can also click the triangle to reveal and directly access topics within the chapters.

When printing pages from Acrobat, use these numbers to specify the page range you wish to print. The page numbers at the top of procedure pages are relative to each chapter, not to the whole document.

Go to Next page

Go to Previous page

Indicates the end of a topic

Indicates a topic that is two or more pages



13 of 448

100%

6.3





Early Macintosh



Macintosh Plus

The Macintosh Plus has no soldered DRAM, but comes with four 256K DRAM SIMMs installed. You can expand the memory to a total of 4 MB by installing DRAM SIMMs. Remember to install the highest density SIMM in Bank A first.

Note: When 1 MB SIMMs are installed, the 256K resistor (R8 or R9) must be clipped or removed to enable recognition of the higher density SIMMs.

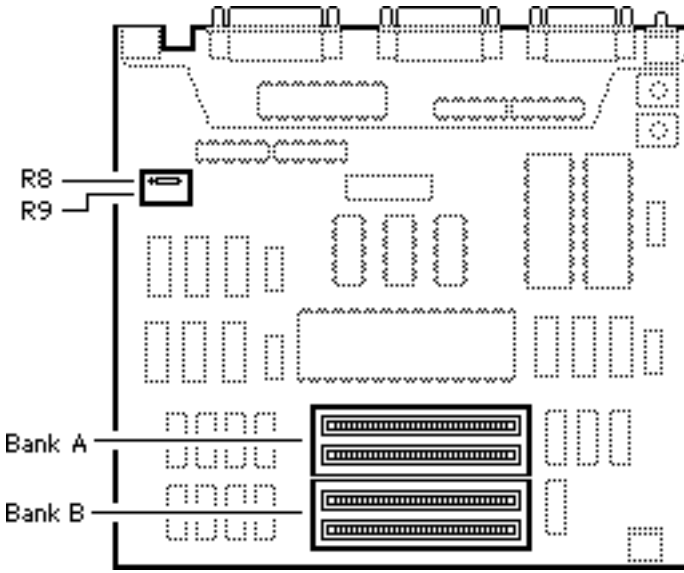

DRAM Configurations	
1 MB	<ul style="list-style-type: none"> • Install four 256K SIMMs. • Leave resistor R8. • Remove resistor R9.
2.5 MB	<ul style="list-style-type: none"> • Install two 1MB SIMMs (Bank A). • Install two 256K SIMMs (Bank B). • Remove resistor R8. • Remove resistor R9.
4 MB	<ul style="list-style-type: none"> • Install four 1MB SIMMs. • Remove resistor R8. • Remove resistor R9.

Memory Information	
DRAM Speed	150 ns
SIMM Type	30-pin
Soldered DRAM	None
Number of SIMM Slots	4
Supported Sizes in MB	256K, 1
Maximum DRAM	4 MB
Virtual Memory	No
Soldered VRAM	None
Number of VRAM Slots	None

Note: Clip one lead of the resistor and move the resistor out of the way so it can be reinstalled if necessary.





Macintosh SE (Solder Type)

The Macintosh SE has no soldered memory. You can expand the memory to a total of 4 MB by installing DRAM SIMMs. Remember, the highest density SIMMs must be installed in Slot 1 and 2 first.

Note: There are two different logic board configurations for the SE, one with a jumper and the other with a resistor to identify the memory level installed.

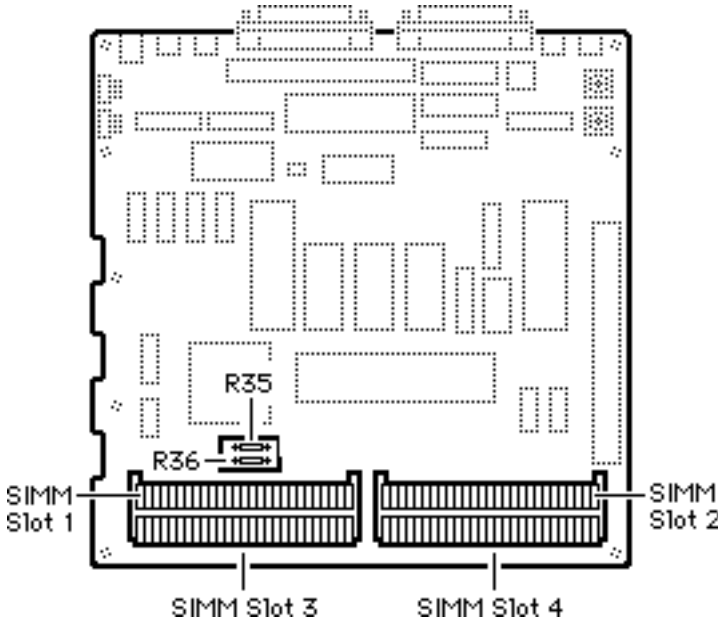

DRAM Configurations	
1 MB	<ul style="list-style-type: none"> • Install four 256K SIMMs. • Leave resistor R35. • Remove resistor R36.
2 MB	<ul style="list-style-type: none"> • Install two 1 MB SIMMs (Slots 1 & 2). • Remove resistor R35. • Leave resistor R36.
2.5 MB	<ul style="list-style-type: none"> • Install two 1MB SIMMs (Slots 1 & 2.) • Install two 256K SIMMs (Slots 3 & 4). • Remove resistor R35. • Remove resistor R36.
4 MB	<ul style="list-style-type: none"> • Install four 1MB SIMMs. • Remove resistor R35. • Remove resistor R36.

Memory Information	
DRAM Speed	150 ns
SIMM Type	30-pin
Soldered DRAM	None
Number of SIMM Slots	4
Supported Sizes in MB	256K, 1
Maximum DRAM	4 MB
Virtual Memory	No
Soldered VRAM	None
Number of VRAM Slots	None

Note: For a 2.5 MB configuration, clip one lead of the resistors and move the resistor out of the way so it can be reinstalled if necessary.





Macintosh SE (Jumper Type)

The Macintosh SE has no soldered memory. You can expand the memory to a total of 4 MB by installing DRAM SIMMs. Remember the highest density SIMMs must be installed in Slot 1 and 2 first.

Note: There are two different logic board configurations for the SE, one with a jumper and the other with a resistor to identify the memory level installed.

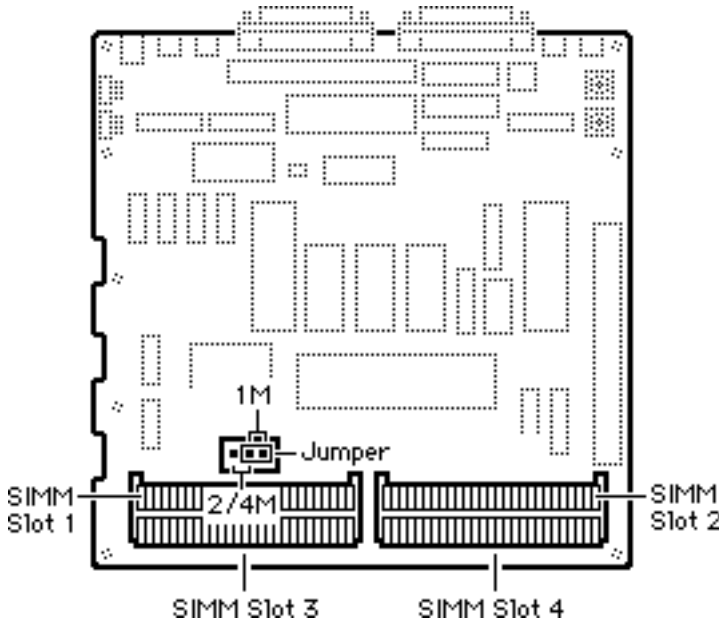

DRAM Configurations	
1 MB	<ul style="list-style-type: none"> • Install four 256K SIMMs. • Install jumper in position "1M".
2 MB	<ul style="list-style-type: none"> • Install two 1 MB SIMMs (Slots 3 & 4). • Install jumper in position "2/4M".
2.5 MB	<ul style="list-style-type: none"> • Install two 256K SIMMs (Slots 1 & 2). • Install two 1 MB SIMMs (Slots 3 & 4). • Remove jumper.
4 MB	<ul style="list-style-type: none"> • Install four 1 MB SIMMs. • Remove jumper.

Memory Information	
DRAM Speed	150 ns
SIMM Type	30-pin
Soldered DRAM	None
Number of SIMM Slots	4
Supported Sizes in MB	256K, 1
Maximum DRAM	4 MB
Virtual Memory	No
Soldered VRAM	None
Number of VRAM Slots	None

Note: The jumper must be removed for a 2.5 MB configuration. Place the jumper on one pin so it can be reinstalled if necessary.





Macintosh SE/30

The Macintosh SE/30 has no soldered memory. You can expand the memory to a total of 32 MB by installing DRAM SIMMs.

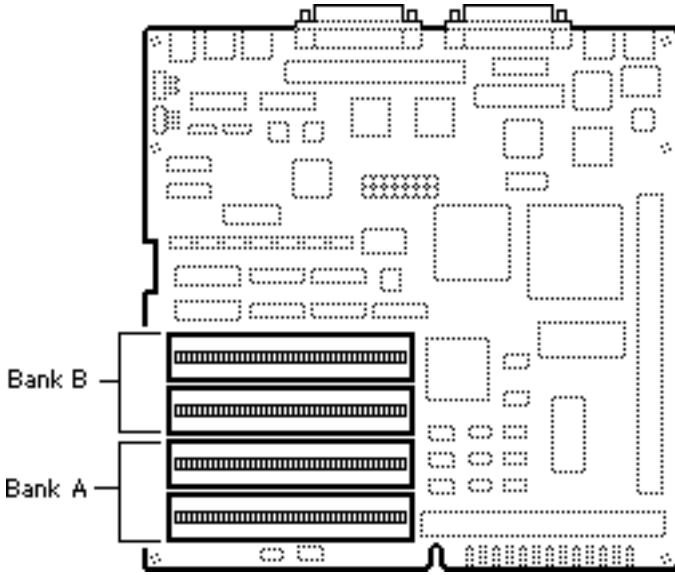

DRAM Configurations		
Total Memory	Bank A	Bank B
1 MB	Four 256K	Empty
2 MB	Four 256K	Four 256K
4 MB	Four 1 MB	Empty
5 MB	Four 1 MB	Four 256K
8 MB	Four 1 MB	Four 1 MB
16 MB	Four 4 MB	Empty
17 MB	Four 256K	Four 4 MB
20 MB	Four 4 MB	Four 1 MB
32 MB	Four 4 MB	Four 4 MB

Memory Information	
DRAM Speed	120 ns
SIMM Type	30-pin
Soldered DRAM	None
Number of SIMM Slots	8
Supported Sizes in MB	256K, 1, 4
Maximum DRAM	32 MB
Virtual Memory	1 GB (with MODE32 7.5 installed)
Soldered VRAM	None
Number of VRAM Slots	None

Note: You must fill each bank of four slots with similar sized SIMMs.





Macintosh Classic

The Macintosh Classic comes with 1 MB of soldered DRAM. The memory expansion card has 1 MB soldered on and two SIMM slots. Using two 1 MB SIMMs, a maximum of 4 MB is possible.

Note: Be sure to configure the jumper as shown when memory is added to the card.

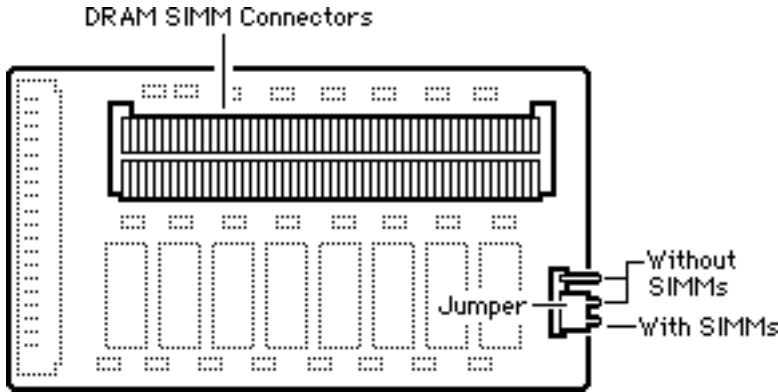

DRAM Configurations	
1 MB	The Classic logic board has 1 MB of soldered DRAM.
2 MB	<ul style="list-style-type: none"> Install a Classic Memory Expansion Board with no SIMMs installed. Install the jumper in the "Without SIMMs Installed" position.
2.5 MB	<ul style="list-style-type: none"> Install a Classic Memory Expansion Board with two 256K SIMMs installed. Use 120 ns or faster 30-pin SIMMs. Install the jumper in the "With SIMMs Installed" position.
4 MB	<ul style="list-style-type: none"> Install a Classic Memory Expansion Board with two 1 MB SIMMs installed. Install the jumper in the "With SIMMs Installed" position.

Memory Information	
DRAM Speed	150 ns
SIMM Type	30-pin
Soldered DRAM	1 MB
Number of SIMM Slots	2
Supported Sizes in MB	256K, 1
Maximum DRAM	4 MB
Virtual Memory	No
Soldered VRAM	None
Number of VRAM Slots	None

Note: The Macintosh Classic can perform erratically if 1MB SIMMs containing two chips are installed. When installing memory, be sure to use 8 chip SIMMs.





Classic II

The Macintosh Classic II has 2 MB of soldered DRAM. You can expand the memory to a total of 10MB by installing DRAM SIMMs.

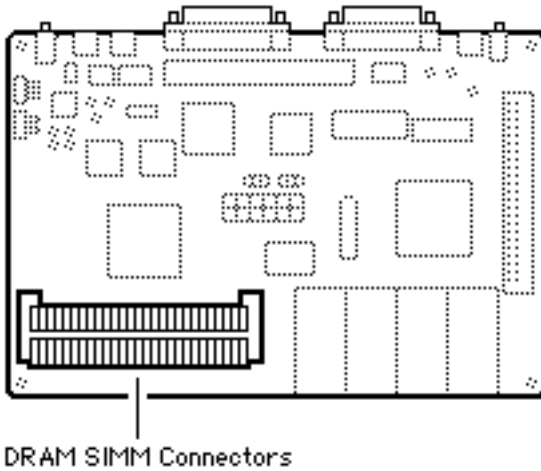

DRAM Configurations	
2 MB	The Macintosh Classic II logic board has 2 MB of soldered DRAM.
4 MB	Install two 1 MB SIMMs.
6 MB	Install two 2 MB SIMMs.
10 MB	Install two 4 MB SIMMs.

Note: You must fill both DRAM slots.

Memory Information	
DRAM Speed	100 ns
SIMM Type	30-pin
Soldered DRAM	2 MB
Number of SIMM Slots	2
Supported Sizes in MB	1, 2, 4
Maximum DRAM	10 MB
Virtual Memory	1 GB
Soldered VRAM	None
Number of VRAM Slots	None





Color Classic

The Macintosh Color Classic comes with 4 MB of soldered DRAM. You can expand the memory to a total of 10 MB by installing DRAM SIMMs. (Total memory is 12 MB but the Color Classic can address 10 MB maximum.)

You must fill both DRAM slots.

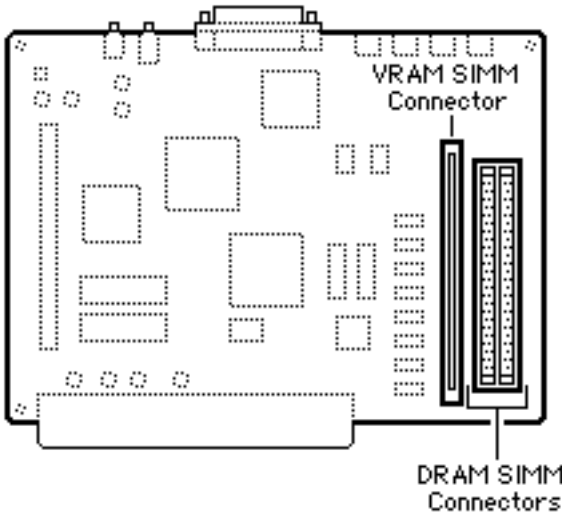

DRAM Configurations	
4 MB	The Macintosh Color Classic logic board has 4 MB of soldered DRAM.
6 MB	Install two 1 MB SIMMs.
8 MB	Install two 2 MB SIMMs.
10 MB	Install two 4 MB SIMMs.

Note: The Color Classic can address 10 MB of DRAM maximum. When you install 4 MB SIMMs, 2 MB of memory can't be addressed.

VRAM Configurations	
256K	The Color Classic logic board has 256K of soldered VRAM.
512K	Install one 256K VRAM SIMM.

Memory Information	
DRAM Speed	100 ns
SIMM Type	30-pin
Soldered DRAM	4 MB
Number of SIMM Slots	2
Supported Sizes in MB	1, 2, 4
Maximum DRAM	10 MB
Virtual Memory	1 GB
Soldered VRAM	256K
Number of VRAM Slots	1
Maximum VRAM	512K
VRAM Speed	100ns





Color Classic II (International Only)

The Color Classic II and Performa 275 logic boards have 4 MB of soldered DRAM. You can expand the memory to a total of 10 MB by installing DRAM SIMMs.

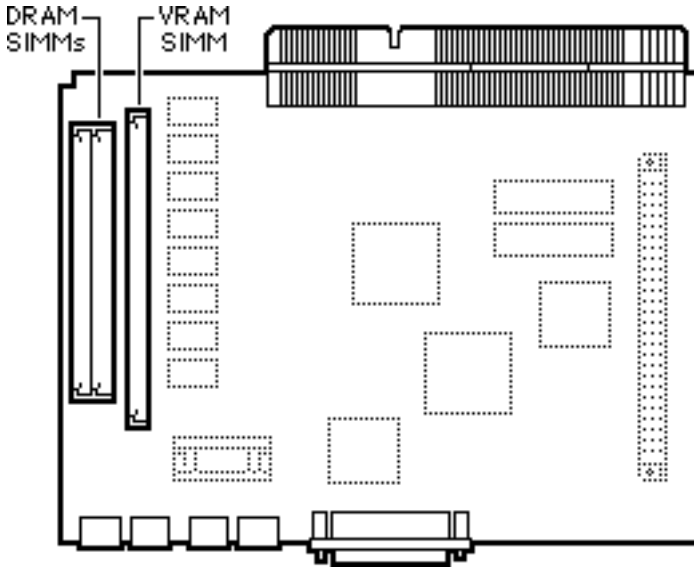

DRAM Configurations	
4 MB	The Macintosh Color Classic logic board has 4 MB of soldered DRAM.
6 MB	Install two 1 MB SIMMs.
8 MB	Install two 2 MB SIMMs.
10 MB	Install two 4 MB SIMMs.

Memory Information	
DRAM Speed	100 ns
SIMM Type	30-pin
Soldered DRAM	4 MB
Number of SIMM Slots	2
Supported Sizes in MB	1, 2, 4
Maximum DRAM	10 MB
Virtual Memory	1 GB
Soldered VRAM	256K
Number of VRAM Slots	1

VRAM Configurations	
256K	The Color Classic II logic board has 256K of soldered VRAM.
512K	Install one 256K VRAM SIMM.





Macintosh TV

The Macintosh TV logic board has 4 MB of soldered DRAM. You can expand the memory to a total of 8 MB by installing DRAM SIMMs.

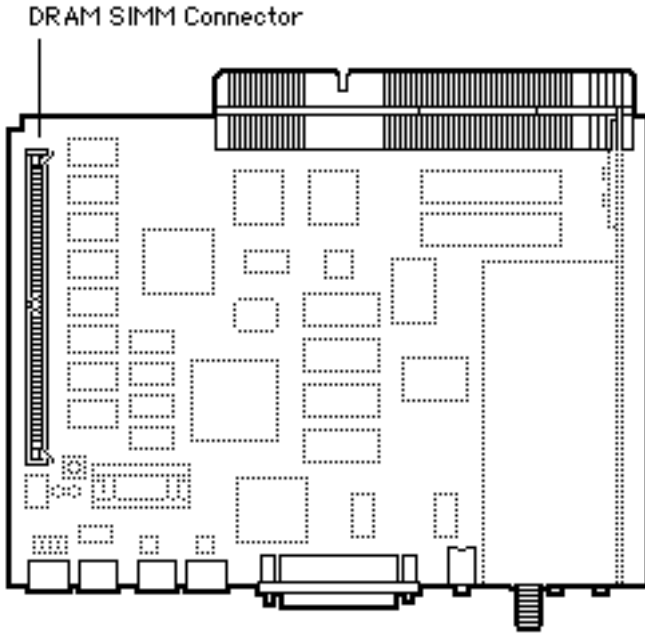

DRAM Configurations	
4 MB	The Macintosh TV logic board has 4 MB of soldered DRAM.
5 MB	Install one 1 MB SIMM.
8 MB	Install one 4 MB SIMM.

Note: A total of 5 MB of memory (soldered DRAM plus one 1 MB SIMM) is standard.

Note: The Macintosh TV is not upgradable beyond 8 MB of RAM.

Memory Information	
DRAM Speed	80 ns
SIMM Type	72-pin
Soldered DRAM	4 MB
Number of SIMM Slots	1
Supported Sizes in MB	1, 4
Maximum DRAM	8 MB
Virtual Memory	1 GB
Soldered VRAM	512K
Number of VRAM Slots	None





Macintosh II

The Macintosh II originally shipped in a number of configurations. It requires PAL type SIMMs in densities higher than 1MB. Verify with your memory vendor that the SIMMs are compatible with the Macintosh II.

Note: Mitsubishi 1 MB SIMMs for the Macintosh IIx, which are labeled "For 030 System Only," should be used only in systems with 68030 microprocessors.

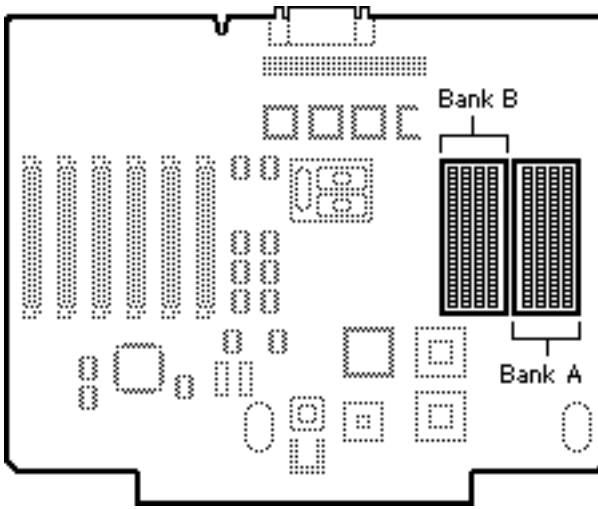

DRAM Configurations

Total Memory	Bank A	Bank B
1 MB	Four 256K	Empty
2 MB	Four 256K	Four 256K
4 MB	Four 1 MB	Empty
5 MB	Four 1 MB	Four 256K
8 MB	Four 1 MB	Four 1 MB
16 MB	Four 4 MB	Empty
17 MB	Four 4 MB	Four 256K
20 MB	Four 4 MB	Four 1 MB

Note: You must fill an entire bank of four SIMMs when upgrading memory.

Memory Information

DRAM Speed	120 ns
SIMM Type	30-pin
Soldered DRAM	None
Number of SIMM Slots	8
Supported Sizes in MB	256K, 1, 4, 16
Maximum DRAM	128 MB (see Note)
Virtual Memory	1 GB (with MODE32 7.5 installed)
Soldered VRAM	None
Number of VRAM Slots	None

Note: If 4 MB or 16 MB SIMMs are used, they cannot be installed in Bank A. If the SuperDrive Upgrade (M6051/C) and the 68851 PMMU Upgrade Kit are installed, this anomaly is alleviated and the 128 MB configuration is possible.





Macintosh IIx

The Macintosh IIx originally shipped in a number of configurations. Both systems require PAL type SIMMs in densities higher than 1 MB. Verify with your memory vendor that the SIMMs are compatible with the IIx.

You must fill an entire bank of four SIMMs when upgrading memory.

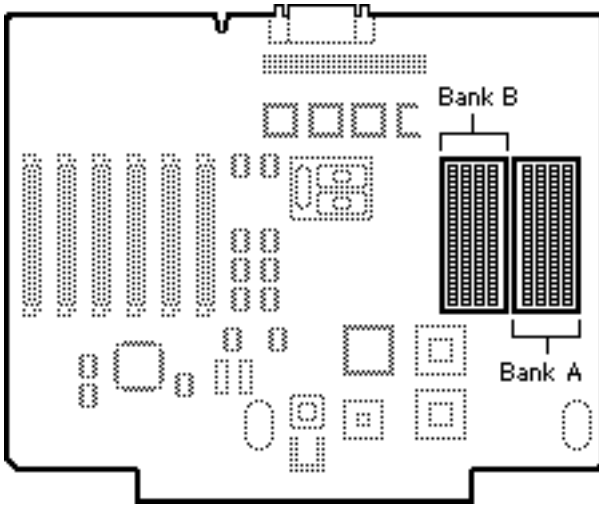

DRAM Configurations		
Total Memory	Bank A	Bank B
1 MB	Four 256K	Empty
2 MB	Four 256K	Four 256K
4 MB	Four 1 MB	Empty
5 MB	Four 1 MB	Four 256K
8 MB	Four 1 MB	Four 1 MB
16 MB	Four 4 MB	Empty
17 MB	Four 4 MB	Four 256K
20 MB	Four 4 MB	Four 1 MB
32 MB	Four 4 MB	Four 4 MB

Memory Information	
DRAM Speed	120 ns
SIMM Type	30-pin
Soldered DRAM	None
Number of SIMM Slots	8
Supported Sizes in MB	256K, 1, 4, 16
Maximum DRAM	128 MB
Virtual Memory	1 GB (with MODE32 7.5 installed)
Soldered VRAM	None
Number of VRAM Slots	None

Note: You must fill an entire bank of four SIMMs when upgrading memory.





Macintosh IIx

The Macintosh IIx uses 64-pin SIMMs similar to those used in the LaserWriter IINTX. Do **not** use NTX SIMMs in the Macintosh IIx as they are not the correct speed.

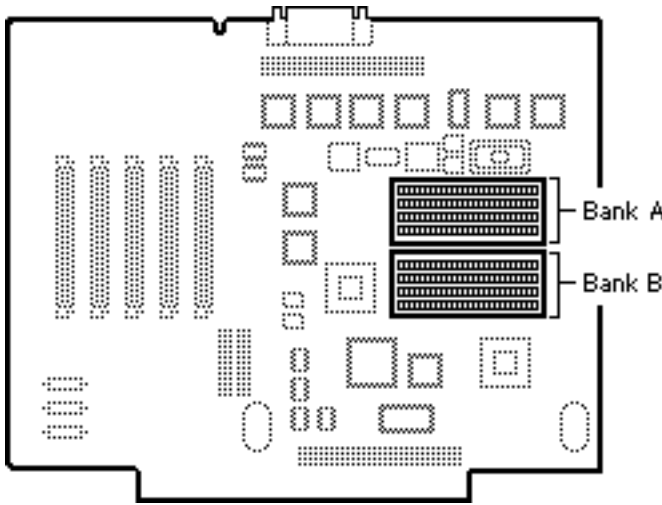

DRAM Configurations		
Total Memory	Bank A	Bank B
4 MB	Four 1 MB	Empty
8 MB	Four 1 MB	Four 1 MB
16 MB	Four 4 MB	Empty
20 MB	Four 4 MB	Four 1 MB
32 MB	Four 4 MB	Four 4 MB

Memory Information	
DRAM Speed	80 ns
SIMM Type	64-pin
Soldered DRAM	None
Number of SIMM Slots	8
Supported Sizes in MB	1, 4, 16
Maximum DRAM	128 MB
Virtual Memory	1 GB
Soldered VRAM	None
Number of VRAM Slots	None

Note: You must fill an entire bank of four SIMMs when upgrading memory.





Macintosh IIcx

The IIcx has no soldered DRAM. You can expand the memory to a total of 128 MB by installing DRAM SIMMs.

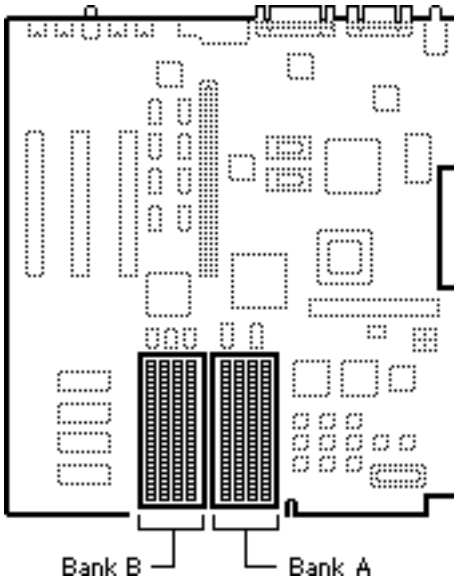

DRAM Configurations		
Total Memory	Bank A	Bank B
1 MB	Four 256K	Empty
2 MB	Four 256K	Four 256K
4 MB	Four 1 MB	Empty
5 MB	Four 1 MB	Four 256K
8 MB	Four 1 MB	Four 1 MB
16 MB	Four 4 MB	Empty
17 MB	Four 4 MB	Four 256K
20 MB	Four 4 MB	Four 1 MB
32 MB	Four 4 MB	Four 4 MB

Memory Information	
DRAM Speed	120 ns
SIMM Type	30-pin
Soldered DRAM	None
Number of SIMM Slots	8
Supported Sizes in MB	256K, 1, 4, 16
Maximum DRAM	128 MB
Virtual Memory	1 GB (with MODE32 7.5 installed)
Soldered VRAM	None
Number of VRAM Slots	None

Note: You must fill an entire bank of four SIMMs when upgrading memory.





Macintosh IIci

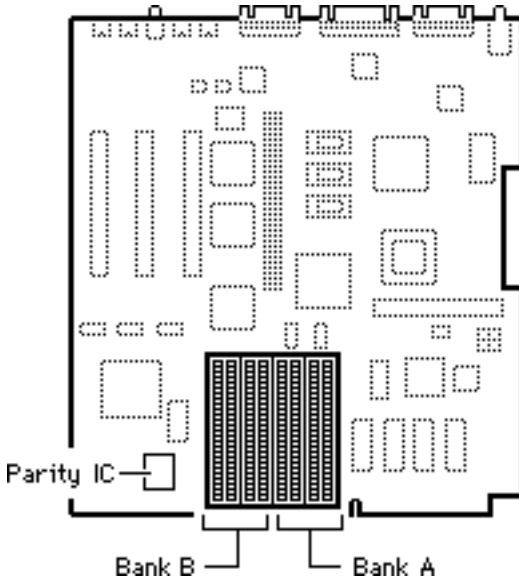

There are two logic boards for the Macintosh IIci, one with and one without parity. You can identify the Parity logic board by the large parity IC installed to the left of the SIMM slots.

If you have a parity logic board (identified by the presence of the parity chip at the location noted), be sure to install parity SIMMs for proper operation.

DRAM Configurations		
Total Memory	Bank A	Bank B
1 MB	Four 256K	Empty
2 MB	Four 256K	Four 256K
3 MB	Four 512K	Four 256K
4 MB	Four 1 MB	Empty
5 MB	Four 1 MB	Four 256K
8 MB	Four 1 MB	Four 1 MB
16 MB	Four 4 MB	Empty
17 MB	Four 4 MB	Four 256K
20 MB	Four 4 MB	Four 1 MB

Memory Information	
DRAM Speed	80 ns
SIMM Type	30-pin
Soldered DRAM	None
Number of SIMM Slots	8
Supported Sizes in MB	256K, 512K, 1, 2, 4, 16
Maximum DRAM	128 MB
Virtual Memory	1 GB
Soldered VRAM	None
Number of VRAM Slots	None

Note: The IIci uses DRAM for video and maps it to Bank A. Contrary to other Macintosh models, always install the lowest density SIMMs in Bank A for best performance.

Note: You must fill an entire bank of four SIMMs when upgrading memory.

Note: Use 80 ns or faster fast-page-mode SIMMs.





Macintosh IIsi

The Macintosh IIsi has 1 MB soldered to the logic board and is expandable to 17 MB (Bank A).

You must fill all four SIMM slots in Bank B when expanding memory.

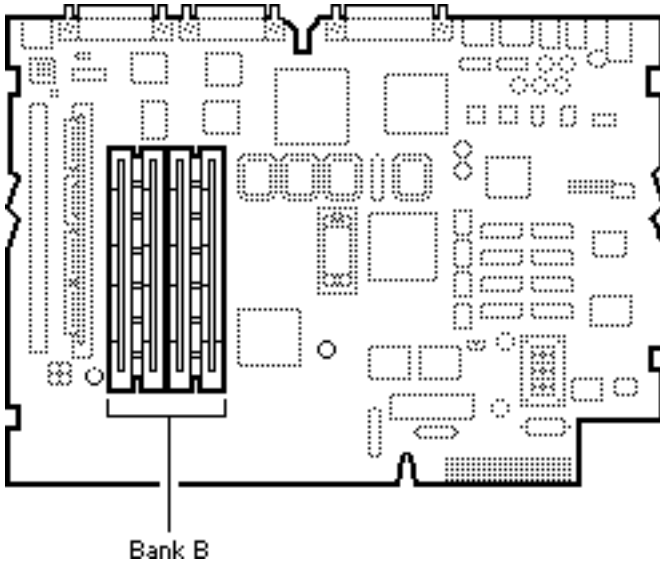

DRAM Configurations		
Total Memory	Bank A (soldered)	Bank B
2 MB	1 MB	Four 256K
3 MB	1 MB	Four 512K
5 MB	1 MB	Four 1 MB
9 MB	1 MB	Four 2 MB
17 MB	1 MB	Four 4 MB

Memory Information	
DRAM Speed	100 ns
SIMM Type	30-pin
Soldered DRAM	1 MB
Number of SIMM Slots	4
Supported Sizes in MB	256K, 512K, 1, 2, 4
Maximum DRAM	17 MB
Virtual Memory	1 GB
Soldered VRAM	None
Number of VRAM Slots	None





Macintosh IIvx, IIvi

The Macintosh IIvx and IIvi have 4 MB soldered to the logic board and are expandable to 68 MB.

Note: A total of 5 MB of memory (soldered DRAM plus one 1 MB SIMM) is standard on the Performa 600.

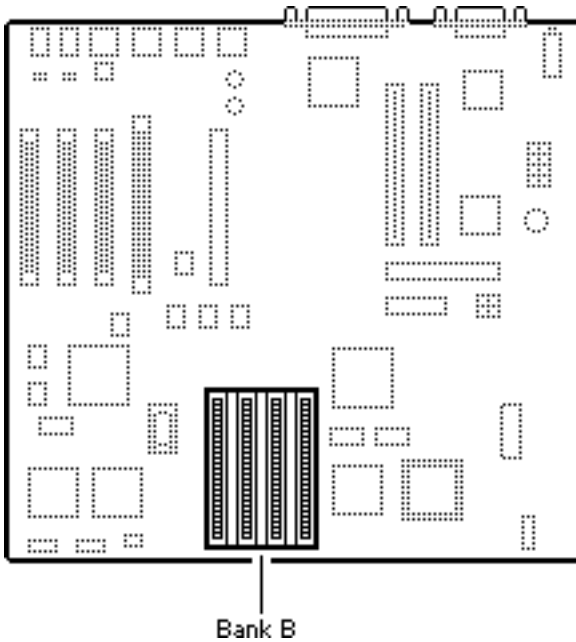

DRAM Configurations		
Total Memory	Bank A (soldered)	Bank B
4 MB	4 MB	Empty
5 MB	4 MB	Four 256K
8 MB	4 MB	Four 1 MB
12 MB	4 MB	Four 2 MB
20 MB	4 MB	Four 4 MB
68 MB	4 MB	Four 16 MB

Note: You must fill an entire bank of four SIMMs when upgrading memory.

VRAM Configurations	
512K	Install two 256K VRAM SIMMs.
1 MB	Install two 512K VRAM SIMMs.

Memory Information	
DRAM Speed	80 ns
SIMM Type	30-pin
Soldered DRAM	4 MB
Number of SIMM Slots	4
Supported Sizes in MB	256K, 1, 2, 4, 16
Maximum DRAM	68 MB
Virtual Memory	1 GB
Soldered VRAM	None
Number of VRAM Slots	2

Note: Use 80 ns or faster fast-page-mode SIMMs.





Quadra/Centris



Quadra 605

The Quadra 605 has 4 MB of DRAM soldered to the logic board and one expansion slot. Single-sided SIMMs are supported in 1, 4, 8, and 16 MB densities; double-sided SIMMs are supported in 2, 4, and 32 MB densities.

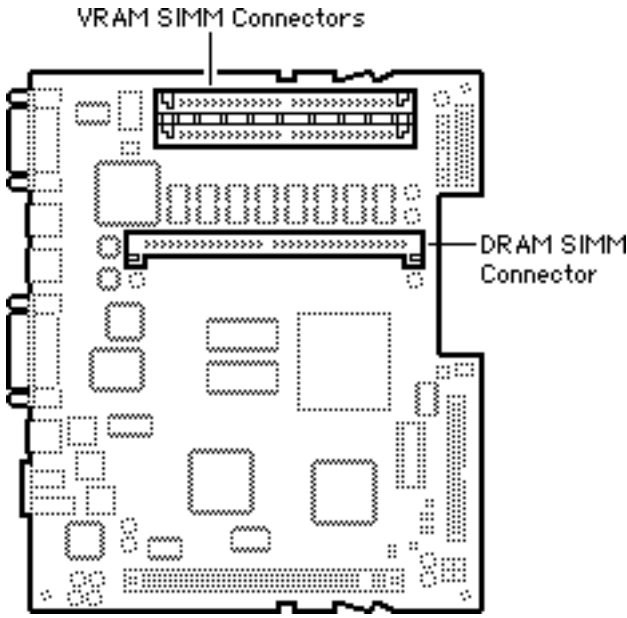

DRAM Configurations	
4 MB	The Macintosh Quadra 605 logic board has 4 MB of soldered DRAM.
5 MB	Install one 1 MB SIMM.
6 MB	Install one 2 MB SIMM.
8 MB	Install one 4 MB SIMM.
12 MB	Install one 8 MB SIMM.
20 MB	Install one 16 MB SIMM.
36 MB	Install one 32 MB SIMM.

Memory Information	
DRAM Speed	80 ns
SIMM Type	72-pin
Soldered DRAM	4 MB
Number of SIMM Slots	1
Supported Sizes in MB	1, 2, 4, 8, 16, 32
Maximum DRAM	36 MB
Virtual Memory	1 GB
Soldered VRAM	None
Number of VRAM Slots	2

VRAM Configurations	
512K	The Quadra 605 logic board has two 256K VRAM SIMMs.
1 MB	Install two 512K VRAM SIMMs.

VRAM Note: The Quadra 605 comes with two 256K VRAM SIMMs installed. You can upgrade the VRAM to a total of 1 MB by replacing the two 256K SIMMs with two 512K SIMMs.





Quadra 630

The Macintosh Quadra 630 has 4 MB of soldered DRAM. Total memory can be expanded to 36 MB.

Note: The Quadra 630 and Performa 63x cpus may have one of two logic boards. One logic board has one SIMM slot (661-0518), the other logic board (661-1114) has two SIMM slots; a regular SIMM slot and a "single-sided" SIMM slot; expandable to 52 MB.

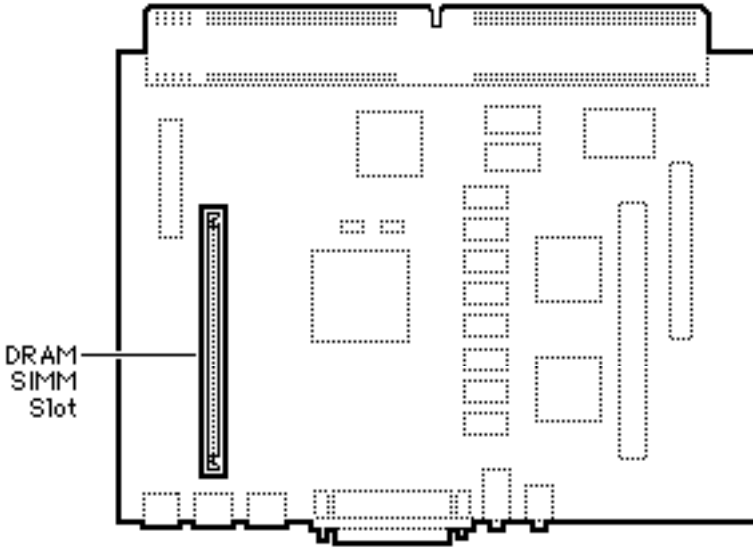

DRAM Configurations	
4 MB	The Macintosh Quadra 630 logic board has 4 MB of soldered DRAM.
36 MB	Use 4, 8, 16, or 32 MB 72-pin SIMMs.
Up to 52 MB	Note: If the customer has the logic board with two SIMM slots (661-1114), the maximum RAM would be 52 MB. To upgrade to 52 MB use a 32 MB SIMM in the regular SIMM slot, and a 16 MB SIMM in the single-sided SIMM slot.

Memory Information	
DRAM Speed	80 ns
SIMM Type	72-pin
Soldered DRAM	4 MB
Number of SIMM Slots	1 or 2 (see Note above)
Supported Sizes in MB	1, 2, 4, 8, 16, 32, 52 MB (see Note above)
Maximum DRAM	36 MB, 52 MB (see Note above)
Virtual Memory	1 GB
Soldered VRAM	1 MB
Number of VRAM Slots	None





Quadra 700

The Quadra 700 has 4 MB of DRAM soldered to the logic board. Total memory can be expanded to 20 MB (see note).

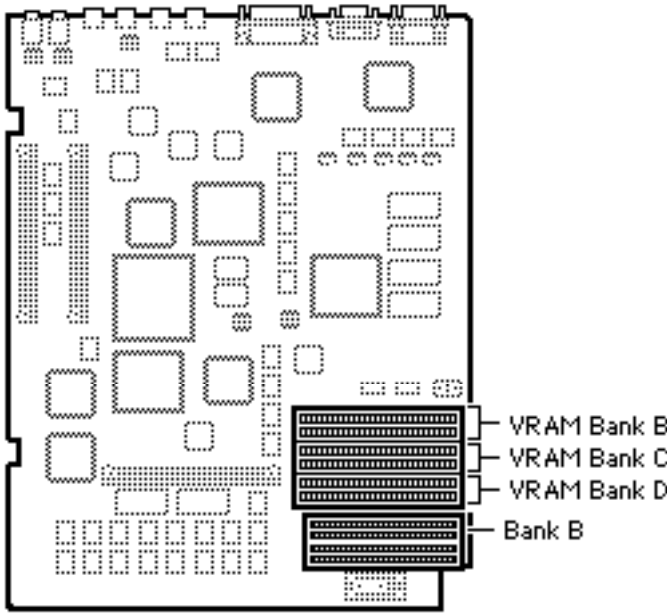

DRAM Configurations	
4 MB	The Macintosh Quadra 700 logic board has 4 MB of soldered DRAM (Bank A).
8 MB	Install four 1 MB SIMMs (Bank B).
20 MB	Install four 4 MB SIMMs (Bank B).
68 MB	Install four 16 MB SIMMs (Bank B).

Memory Information	
DRAM Speed	80 ns or faster
SIMM Type	30-pin, fast-page mode
Soldered DRAM	4 MB
Number of SIMM Slots	4
Supported Sizes in MB	1, 4
Maximum DRAM	20 MB (see Note)
Virtual Memory	1 GB
Soldered VRAM	512k
Number of VRAM Slots	6

VRAM Configurations	
512K	The Quadra 605 logic board has 512K of soldered VRAM.
1 MB	Install two 256K or two 512K VRAM SIMMs.
2 MB	Install six 256K or six 512K VRAM SIMMs.

Note: Memory configurations above 20 MB have not been tested and are not officially supported by Apple Computer, Inc.

Note: VRAM banks must be populated in order. Install the SIMMs in paired slots (B1 and B2 first, then C1 and C2, etc.).

Note: The Macintosh Quadra 700 uses only 256K of each 512K VRAM SIMM installed.





Quadra 800

The Quadra 800 has 8 MB of DRAM soldered to the logic board. Total memory can be expanded to 136 MB.

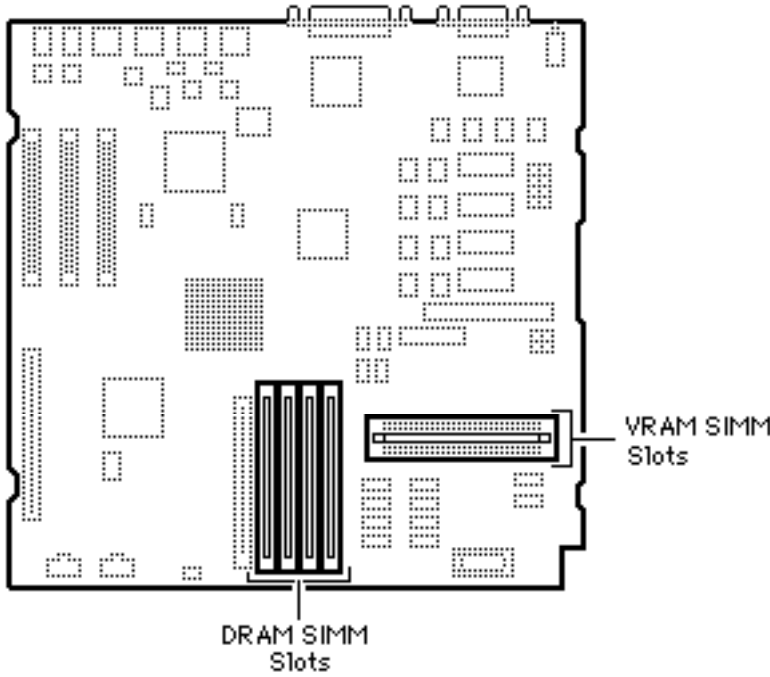

DRAM Configurations	
8 MB	The Macintosh Quadra 800 and Apple WorkGroup Server 80 logic boards have 8 MB of soldered DRAM.
136 MB	Use 1, 4, 8, 16, or 32 MB 72-pin SIMMs.

Memory Information	
DRAM Speed	60 ns
SIMM Type	72-pin
Soldered DRAM	8 MB
Number of SIMM Slots	4
Supported Sizes in MB	1, 4, 8, 16, 32
Maximum DRAM	136 MB
Virtual Memory	1 GB
Soldered VRAM	512K
Number of VRAM Slots	2

The Quadra 800 uses “memory interleaving” which occurs when like SIMM pairs are used (for example two 8 MB SIMMs). Basically, it allows the memory subsystem to write to the same memory address in different banks of memory before incrementing the address. Depending on how memory-intensive the application is, memory interleaving can improve performance 5% to 10%.

Note: Use 80 ns or faster VRAM SIMMs.

VRAM Configurations	
512K	The Quadra 800 logic board has 512K of soldered VRAM.
1 MB	Install two 256K VRAM SIMMs.





Quadra 840AV

The Quadra 840AV has no soldered DRAM. Total memory can be expanded to 128 MB.

The Quadra 840AV does not support 1 MB, 2 MB, or 64 MB SIMMs. This computer operates in 32-bit mode at all times, and cannot be toggled back to 24-bit mode.

IMPORTANT: Do **not** use composite SIMMs in the Quadra 840AV.!

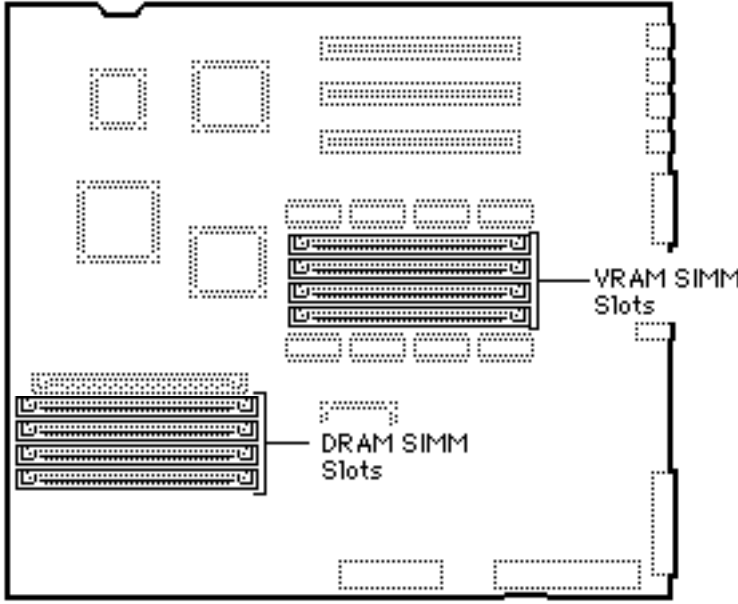

DRAM Configurations	
8 MB	The Macintosh Quadra 840AV logic board has no soldered DRAM. A total of 8 MB of memory (one 8 MB SIMM) is standard.
128 MB	Use 4, 8, 16, or 32 MB 72-pin SIMMs.

Memory Information	
DRAM Speed	60 ns
SIMM Type	72-pin
Soldered RAM	None
Number of SIMM Slots	4
Supported Sizes in MB	4, 8, 16, 32
Maximum DRAM	128 MB
Virtual Memory	1 GB
Soldered VRAM	1 MB
Number of VRAM Slots	4

VRAM Configurations	
1 MB	The Quadra 840AV logic board has 1 MB of soldered VRAM.
2 MB	Install four 256K VRAM SIMMs.

Note: You can mix SIMM sizes.

Note: Use 80 ns or faster VRAM SIMMs.





Quadra 900 and 950

The Quadra 900 and 950 have no soldered DRAM. Total memory can be expanded to 256 MB.

IMPORTANT: Do **not** use composite SIMMs in the Quadra 900 or 950.

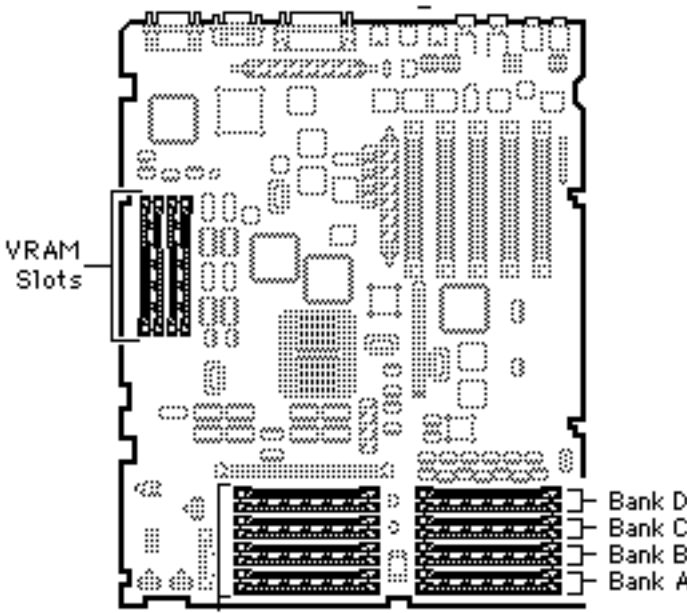

DRAM Configurations	
8 MB	The Quadra 900 and 950 logic boards have no soldered DRAM. A total of 8 MB of memory (one 8 MB SIMM) is standard.
Up to 256 MB	Use 1, 4, or 16 MB 30-pin SIMMs.

Memory Information	
DRAM Speed	80 ns
SIMM Type	30-pin
Soldered RAM	none
Number of SIMM Slots	16
Supported Sizes in MB	1, 4, 8, 16 (see Note)
Maximum DRAM	256 MB
Virtual Memory	1 GB
Soldered VRAM	1 MB
Number of VRAM Slots	4

VRAM Configurations	
2 MB	Install four 256K or two 512K VRAM SIMMs.

Note: Use 80 ns or faster VRAM SIMMs. The Macintosh Quadra 900 and 950 use only 256K of each 512K VRAM SIMM installed.

Note: 8 MB and 16 MB SIMMs have not been tested and are not officially supported on the Quadra 900 and 950.

Note: Fill a bank with DRAM SIMMs of the same size or leave the bank empty (no partially filled banks).





Quadra/Centris 610

The Quadra 610 has 4 MB of DRAM soldered to the logic board. It is functionally equivalent to the Centris 610 and the Workgroup Server 60.

The Quadra 610 has a flexible memory system, meaning that any supported SIMM size can go into any SIMM socket in any order, and they can run with partially populated banks.

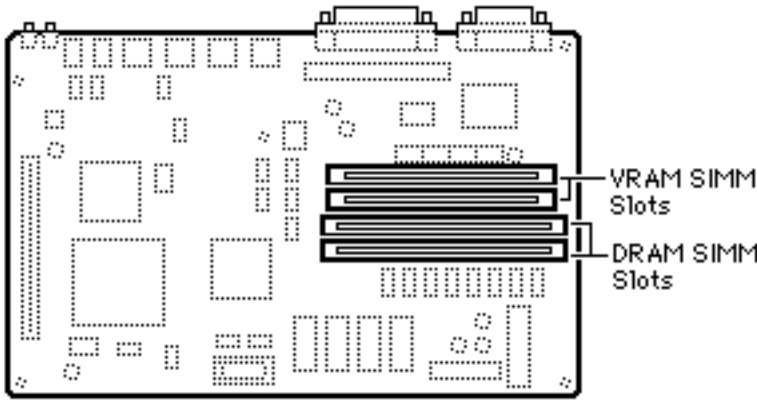

DRAM Configurations	
4/8 MB	The Macintosh Quadra 610 and Centris 610 logic boards have 4 or 8 MB of soldered DRAM.
Up to 72 MB	Use 4, 8, 16, or 32 MB 72-pin SIMMs.

The Centris/Quadra 610 uses “memory interleaving” which occurs when like SIMM pairs are used (for example: two 8MB SIMMs). Basically, it allows the memory subsystem to write to the same memory address in different banks of memory before incrementing the address. Depending on how memory intensive the application is, memory interleaving can improve performance 5% to 10%.

VRAM Configurations	
512K	The Quadra 610 logic board has 512K of soldered VRAM.
1 MB	Install two 256K VRAM SIMMs.

Memory Information	
DRAM Speed	80 ns
SIMM Type	72-pin
Soldered DRAM	4 MB
Number of SIMM Slots	2
Supported Sizes in MB	4, 8, 16, 32
Maximum DRAM	68 MB
Virtual Memory	1 GB
Soldered VRAM	512K
Number of VRAM Slots	2

Note: You can mix SIMM sizes.

Note: The 610 does **not** support 1, 2, or 64 MB SIMMs.

IMPORTANT: Do **not** use composite SIMMs in the Quadra 610.

Note: Use 80 ns or faster VRAM SIMMs.





Quadra/Centris 650

The Centris 650 shipped with 4 MB of soldered DRAM, and the Quadra 650 with 8MB of soldered DRAM. Total memory can be expanded to 132 MB and 136 MB respectively.

Note: The 650 has a flexible memory system, meaning that any supported SIMM size can go into any SIMM slot in any order, and they can run with partially populated banks.

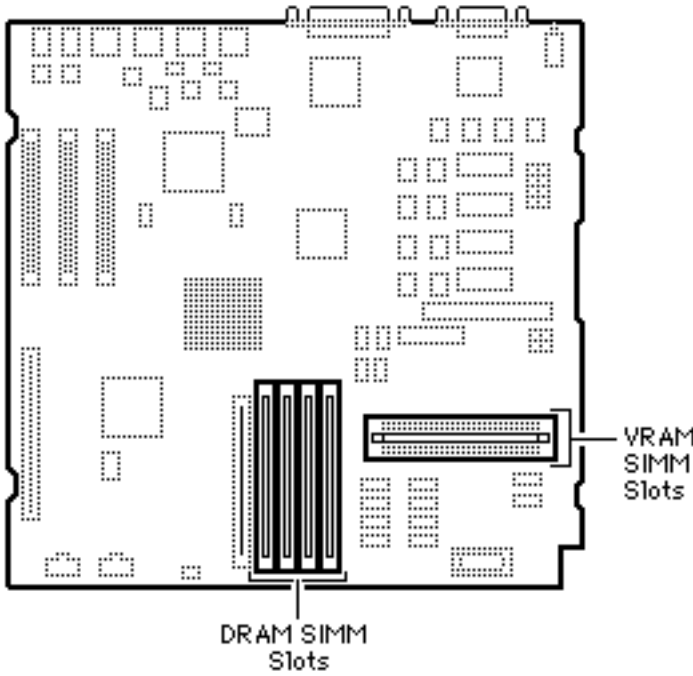

DRAM Configurations	
Up to 132/136 MB	Use 4, 8, 16, or 32 MB 72-pin SIMMs.

The Centris/Quadra 650 uses “memory interleaving” which occurs when like SIMM pairs are used (for example: two 8MB SIMMs). Basically, it allows the memory subsystem to write to the same memory address in different banks of memory before incrementing the address. Depending on how memory intensive the application is, memory interleaving can improve performance 5% to 10%.

VRAM Configurations	
512K	The 650 logic board has 512K of soldered VRAM.
1 MB	Install two 256K VRAM SIMMs.

Note: Use 80 ns or faster VRAM SIMMs.

Memory Information	
DRAM Speed	80 ns
SIMM Type	72-pin
Soldered DRAM	4/8 MB
Number of SIMM Slots	4
Supported Sizes in MB	4, 8, 16, 32
Maximum DRAM	132/136 MB
Virtual Memory	1 GB
Soldered VRAM	512K
Number of VRAM Slots	2

IMPORTANT: Do not use composite SIMMs in the Centris/Quadra 650.

Note: The 650 does **not** support 1, 2, or 64 MB SIMMs.





Quadra/Centris 660AV

The Quadra and Centris 660AV machines are functionally equivalent. Both operate in 32-bit mode at all times and cannot be toggled back to 24-bit mode.

The Quadra 660AV does **not** support 1, 2, or 64 MB SIMMs. However, this computer can run with partially populated banks and you can install any supported SIMM size in any SIMM slot in any order.

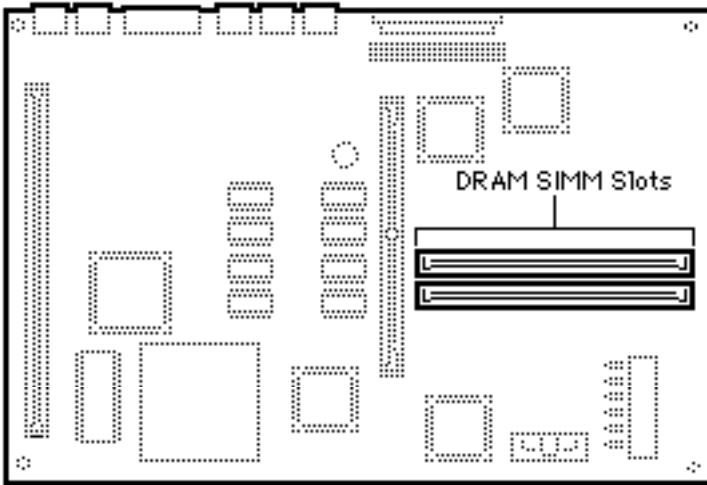

DRAM Configurations	
4 MB	The Macintosh Quadra 660AV and Centris 660AV logic boards have 4 MB of soldered DRAM.
Up to 68 MB	Use 1, 2, 4, 8, 16, or 32 MB 72-pin SIMMs.

Memory Information	
DRAM Speed	70 ns
SIMM Type	72-pin
Soldered DRAM	4 MB
Number of SIMM Slots	2
Supported Sizes in MB	4, 8, 16, 32
Maximum DRAM	68 MB
Virtual Memory	1 GB
Soldered VRAM	1 MB
Number of VRAM Slots	None

Note: You can mix SIMM sizes.





Macintosh LC



Macintosh LC

The Macintosh LC has 2 MB of soldered DRAM. You can expand the memory to a total of 10 MB by installing DRAM SIMMs.

You must fill both slots when upgrading memory.

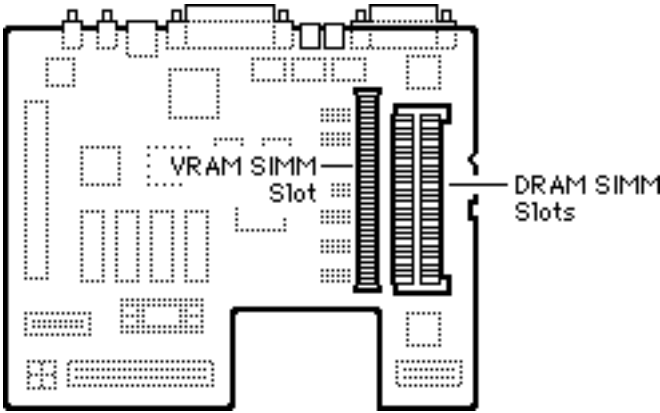

DRAM Configurations	
2 MB	The Macintosh LC logic board has 2 MB of soldered DRAM.
4 MB	Install two 1 MB SIMMs.
6 MB	Install two 2 MB SIMMs.
10 MB	Install two 4 MB SIMMs.

VRAM Configurations	
256K	Install one 256K VRAM SIMM.
512K	Install one 512K VRAM SIMM.

Note: The Macintosh LC has no soldered VRAM but has one VRAM SIMM slot with a 256K SIMM installed. VRAM can be upgraded to 512K by removing the 256K SIMM and replacing it with a 512K SIMM.

Memory Information	
DRAM Speed	100 ns
SIMM Type	30-pin
Soldered DRAM	2 MB
Number of SIMM Slots	2
Supported Sizes in MB	1, 2, 4
Maximum DRAM	10 MB
Virtual Memory	n/a
Soldered VRAM	None
Number of VRAM Slots	1

Note: SIMMs can be different speeds, as long as both SIMMs are 100 ns or faster.





Macintosh LC II

The LC II has 2 MB or 4 MB of soldered DRAM. You can expand the memory to a total of 10 MB by installing DRAM SIMMs.

You must fill both slots with matching SIMMs when upgrading memory.

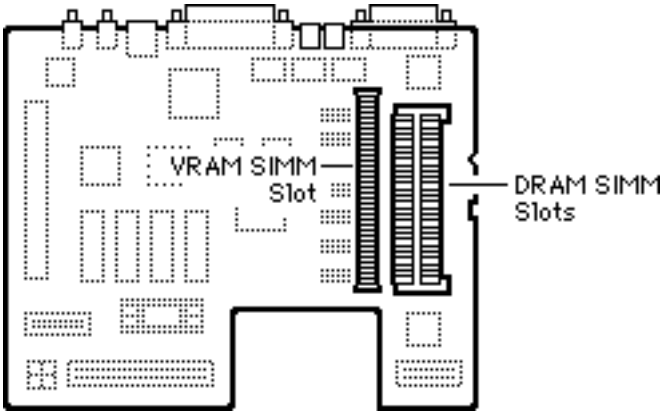

DRAM Configurations	
2/4 MB	The Macintosh LC II has either 2 MB or 4 MB of soldered DRAM.
4/6 MB	Install two 1 MB SIMMs.
6/8 MB	Install two 2 MB SIMMs.
10/12 MB	Install two 4 MB SIMMs.

Note: The Macintosh LC II can address a maximum of 10 MB of DRAM. When you install 4 MB SIMMs, the lower 2 MB of memory on the logic board can't be addressed.

Memory Information	
DRAM Speed	100 ns
SIMM Type	30-pin
Soldered DRAM	4 MB
Number of SIMM Slots	2
Supported Sizes in MB	1, 2, 4
Maximum DRAM	10 MB
Virtual Memory	1 GB
Soldered VRAM	None
Number of VRAM Slots	1

Note: The LC II has no VRAM soldered to the logic board. It comes with a 256K VRAM SIMM installed and can be upgraded to 512K by replacing the 256K SIMM with a 512K SIMM that is 100 ns or faster.

VRAM Configurations	
256K	Install one 256K VRAM SIMM.
512K	Install one 512K VRAM SIMM.





Macintosh LC III

The LC III has 4 MB of soldered DRAM. You can expand the memory to a total of 36 MB by installing DRAM SIMMs.

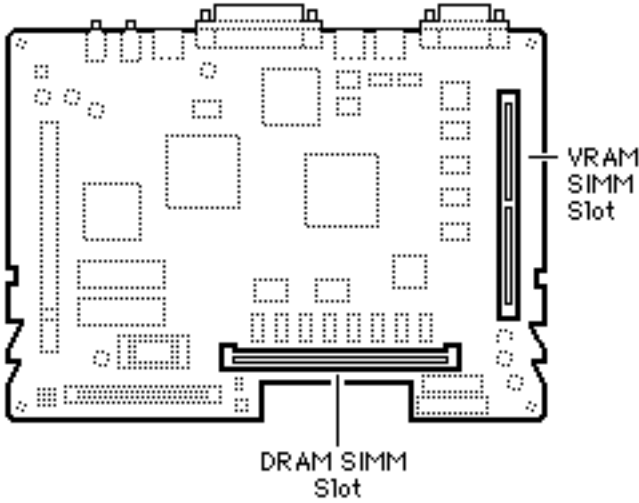

DRAM Configurations	
4 MB	The Macintosh LC III has 4 MB of soldered DRAM.
6 MB	Install one 2 MB SIMMs.
8 MB	Install one 4 MB SIMMs.
12 MB	Install one 8 MB SIMMs.
20 MB	Install one 16 MB SIMMs.
36 MB	Install one 32 MB SIMMs.

Memory Information	
DRAM Speed	80 ns
SIMM Type	72-pin
Soldered DRAM	4 MB (see Note)
Number of SIMM Slots	1
Supported Sizes in MB	1, 2, 4, 8, 16, 32
Maximum DRAM	36 MB
Virtual Memory	1 GB
Soldered VRAM	512K
Number of VRAM Slots	1

VRAM Configurations	
512K	The Macintosh LC III logic board has 512K of soldered VRAM.
768K	Install one 256K VRAM SIMM.
1 MB	Install one 512K VRAM SIMM.

Note: Some LC III upgrade boards have 2 MB of DRAM soldered to the logic board.





Macintosh LC 475

The LC 475 has 4 MB of soldered DRAM. You can expand the memory to a total of 36 MB by installing DRAM SIMMs.

Single-sided SIMMs in 1, 4, 8, and 16 MB densities and double-sided SIMMs in 2, 4, and 32 MB densities are supported.

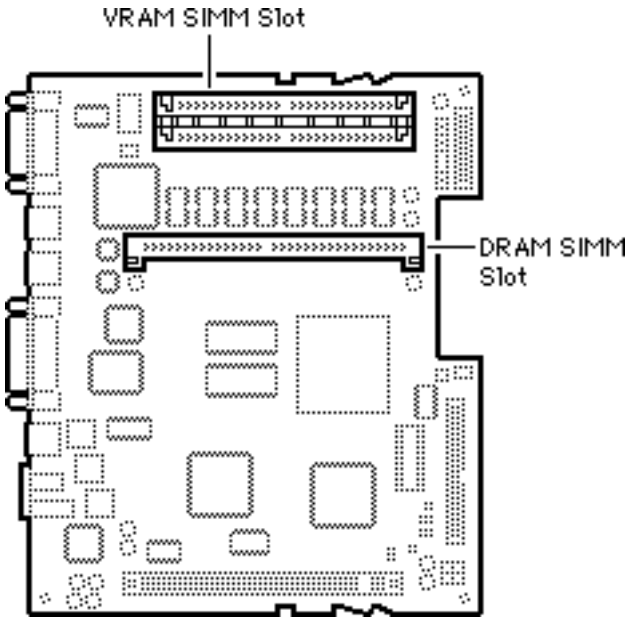

DRAM Configurations	
4 MB	The Macintosh LC 475 logic board has 4 MB of soldered DRAM.
5 MB	Install one 1 MB SIMM.
6 MB	Install one 2 MB SIMM.
8 MB	Install one 4 MB SIMM.
12 MB	Install one 8 MB SIMM.
20 MB	Install one 16 MB SIMM.
36 MB	Install one 32 MB SIMM.

Memory Information	
DRAM Speed	80 ns
SIMM Type	72-pin
Soldered DRAM	4 MB
Number of SIMM Slots	1
Supported Sizes in MB	1, 2, 4, 8, 16, 32
Maximum DRAM	36 MB
Virtual Memory	1 GB
Soldered VRAM	None
Number of VRAM Slots	2

VRAM Configurations	
512K	Install two 256K VRAM SIMMs.
1 MB	Install two 512K VRAM SIMMs.

Note: The LC 475 has 512K of VRAM installed via two 256K VRAM SIMMs. Upgrading to 1 MB of VRAM is accomplished by replacing those SIMMs with two 512K, 68-pin, 80 ns VRAM SIMMs.





Macintosh LC 630 DOS Compatible

The LC 630 DOS Compatible has 8 MB of DRAM: 4 MB soldered on the logic board and one 4 MB SIMM installed. You can expand the memory on the main logic board to a total of 52 MB by installing a 32 MB DRAM SIMM in one slot and a 16 MB DRAM SIMM in the second slot.

The DOS Compatible board ships with one 4 MB DRAM SIMM, and can be upgraded to a total of 32 MB.

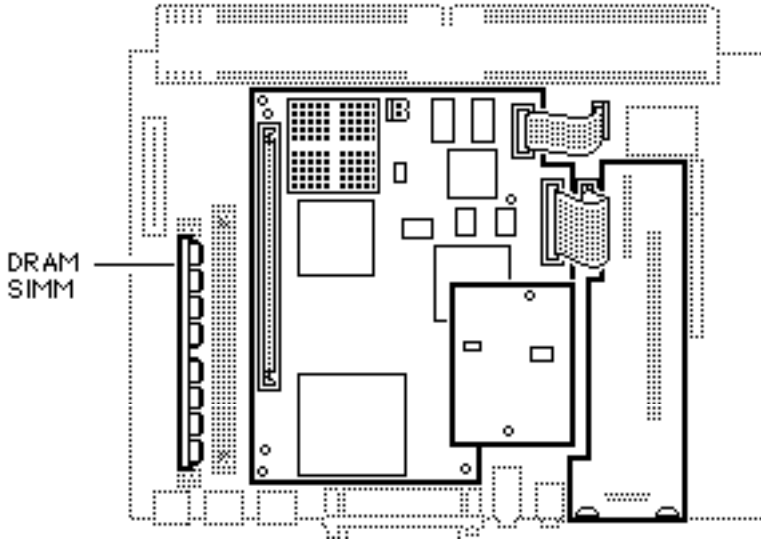

DRAM Configurations	
8 MB	The LC 630 DOS Compatible has 8 MB of DRAM: 4 MB soldered, 4 MB SIMM in one slot.
52 MB	Use various combinations of 72-pin SIMMs up to a total of 52 MB.

Memory Information	
DRAM Speed	80 ns
SIMM Type	72-pin
Soldered DRAM	4 MB
Number of SIMM Slots	1
Supported Sizes in MB	1, 2, 4, 8, 16, 32
Maximum DRAM	52 MB
Virtual Memory	1 GB
Soldered VRAM	1 MB
Number of VRAM Slots	None





LC 520

The Macintosh LC 520 has 4 MB of soldered DRAM and one 1 MB DRAM SIMM installed. You can expand the memory to a total of 36 MB by installing additional DRAM SIMMs.

The LC 520 has 512K of VRAM soldered to the logic board. It can be upgraded to 768K by adding a 256K VRAM SIMM that is rated at 80 ns or faster.

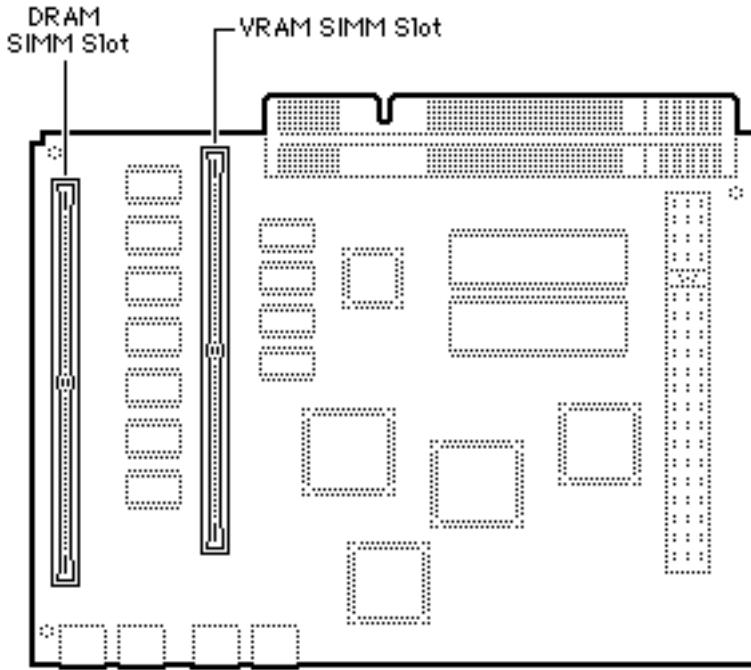

DRAM Configurations	
4 MB	The Macintosh LC 520 has 4 MB of soldered DRAM.
5 MB	Install one 1 MB SIMM.
6 MB	Install one 2 MB SIMM.
8 MB	Install one 4 MB SIMM.
12 MB	Install one 8 MB SIMM.
20 MB	Install one 16 MB SIMM.
36 MB	Install one 32 MB SIMM.

Memory Information	
DRAM Speed	80 ns
SIMM Type	72-pin
Soldered DRAM	4 MB
Number of SIMM Slots	1
Supported Sizes in MB	1, 2, 4, 8, 16, 32
Maximum DRAM	36 MB
Virtual Memory	1 GB
Soldered VRAM	512K
Number of VRAM Slots	1

VRAM Configurations	
512K	The Macintosh LC 520 logic board has 512K of soldered VRAM.
768K	Install one 256K VRAM SIMMs.

Note: Some configurations may come with 768K of VRAM already installed. You can verify this by checking the number of available colors in the monitor control panel. If Thousands of colors are available, the maximum VRAM is installed.





LC 550/575

The LC 550 and LC 575 have 4 MB of soldered DRAM. You can expand the memory to a total of 36 MB by installing DRAM SIMMs.

VRAM is unique between the two machines.

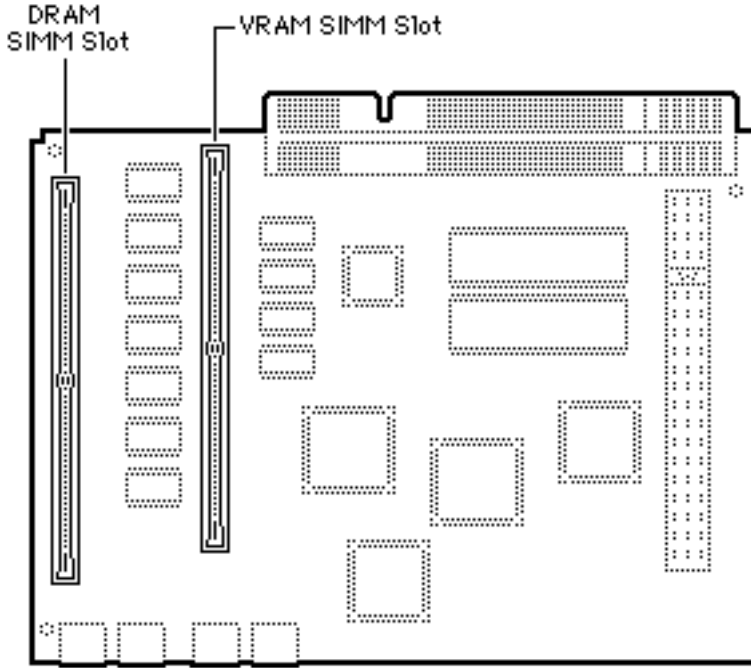

DRAM Configurations	
4 MB	The LC 550/575 logic boards have 4 MB of soldered DRAM.
5 MB	Install one 1 MB SIMM.
6 MB	Install one 2 MB SIMM.
8 MB	Install one 4 MB SIMM.
12 MB	Install one 8 MB SIMM.
20 MB	Install one 16 MB SIMM.
36 MB	Install one 32 MB SIMM.

Memory Information	
DRAM Speed	80 ns
SIMM Type	72-pin
Soldered DRAM	4 MB
Number of SIMM Slots	1
Supported Sizes in MB	1, 2, 4, 8, 16, 32
Maximum DRAM	36 MB
Virtual Memory	1 GB
Soldered VRAM	See VRAM Note
Number of VRAM Slots	See VRAM Note

VRAM Configurations	
512K LC 550	The LC 550 logic board has 512K of soldered VRAM.
1 MB LC 575	Install two 512K VRAM SIMMs.
1 MB LC 550	Install one 512K VRAM SIMM.

VRAM Note: The Macintosh LC 550 has 512K of VRAM soldered to the logic board and one expansion slot. Maximum VRAM is 1 MB. The Macintosh LC 575 has no soldered VRAM and two VRAM SIMM slots. Maximum VRAM is 1 MB.





LC 580

The LC 580 logic board has 4 MB of soldered DRAM. You can expand the memory to a total of 52 MB by installing DRAM SIMMs.

The leftmost SIMM slot (as pictured here) can accommodate a single-sided or double-sided 1, 2, 4, 8, 16, or 32 MB SIMM.

The rightmost SIMM slot (as pictured here) can accept only a single-sided 1, 4, or 16 MB SIMM.

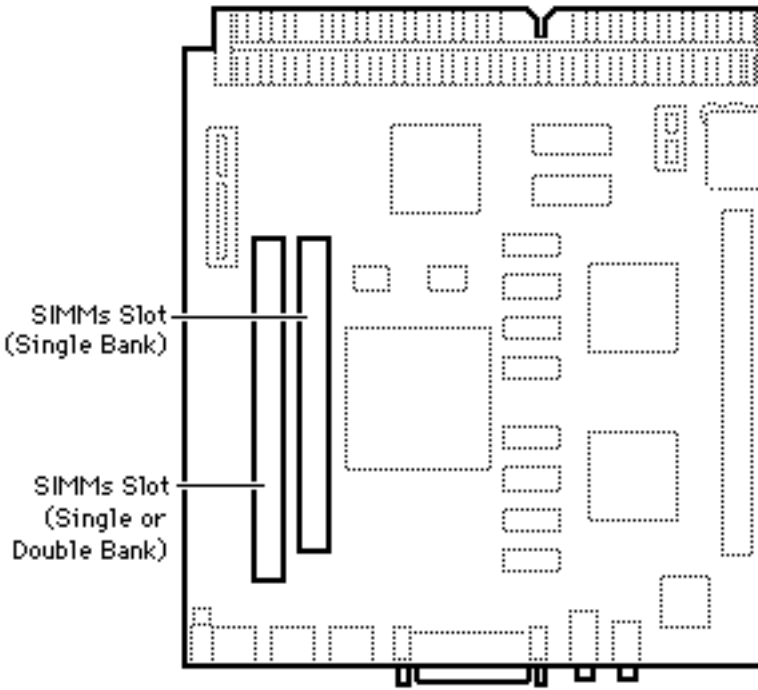

DRAM Configurations	
Up to 52 MB	Use various combinations of 72-pin SIMMs.

Note: The SIMM slots are also marked on the logic board as to which is the slot for the single-sided SIMM.

Memory Information	
DRAM Speed	80 ns
SIMM Type	72-pin
Soldered DRAM	4 MB
Number of SIMM Slots	2
Supported Sizes in MB	See Note
Maximum DRAM	52 MB
Virtual Memory	1 GB
Soldered VRAM	1 MB DRAM
Number of VRAM Slots	None

Note: Supported memory configurations include 6, 7, 9, 10, 12, 13, 21, 22, 24, 28, 36, 37, 40, 46, and 52 MB.





Performa





Performa 200

The Performa 200 has 2 MB of soldered DRAM and comes standard with an additional 2 MB of DRAM installed in two 1 MB SIMMs. You can expand the memory to a total of 10 MB by replacing the two 1 MB SIMMs with two 4 MB SIMMs.

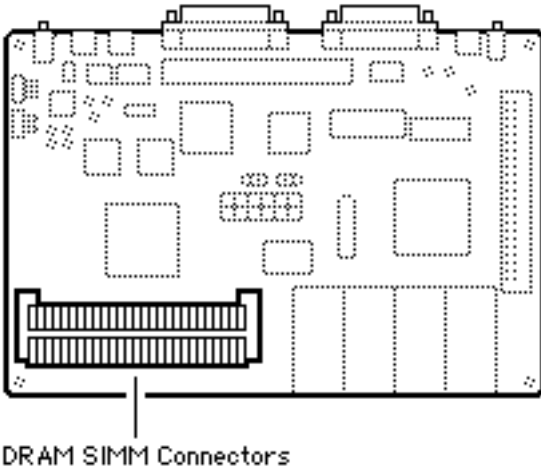

DRAM Configurations	
2 MB	The Performa 200 logic board has 2 MB of soldered DRAM.
4 MB	Install two 1 MB SIMMs.
6 MB	Install two 2 MB SIMMs.
10 MB	Install two 4 MB SIMMs.

Note: You must install SIMMs in both slots.

Memory Information	
DRAM Speed	100 ns
SIMM Type	30-pin
Soldered DRAM	2 MB
Number of SIMM Slots	2
Supported Sizes in MB	1, 2, 4
Maximum DRAM	10 MB
Virtual Memory	1 GB
Soldered VRAM	None
Number of VRAM Slots	None





Performa 275 (International Only)

The Performa 275 logic board has 4 MB of soldered DRAM. You can expand the memory to a total of 10 MB by installing DRAM SIMMs.

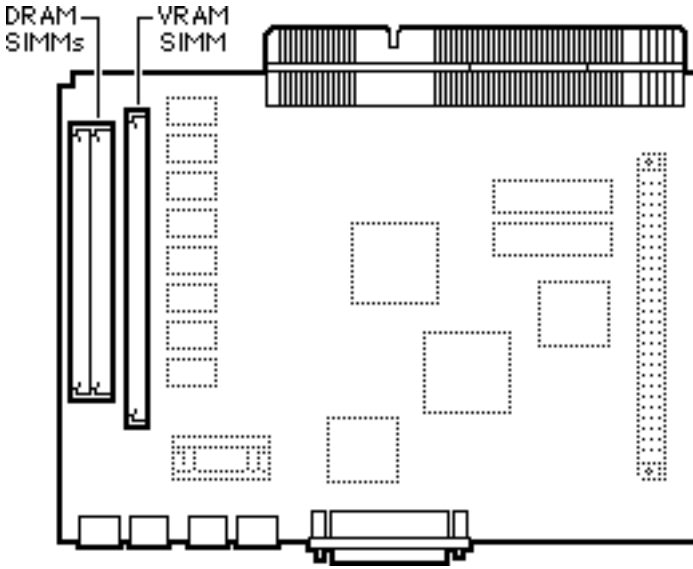

DRAM Configurations	
4 MB	The Performa 275 logic board has 4 MB of soldered DRAM.
6 MB	Install two 1 MB SIMMs.
8 MB	Install two 2 MB SIMMs.
10 MB	Install two 4 MB SIMMs.

VRAM Configurations	
256K	The Performa 275 logic board has 256K of soldered VRAM.
512K	Install one 256K VRAM SIMM.

Memory Information	
DRAM Speed	100 ns
SIMM Type	30-pin
Soldered DRAM	4 MB
Number of SIMM Slots	2
Supported Sizes in MB	1, 2, 4
Maximum DRAM	10 MB
Virtual Memory	1 GB
Soldered VRAM	256K
Number of VRAM Slots	1





Performa 400, 405, 410, 430

The Performa 400, 405, 410, and 430 each have 4 MB of soldered DRAM. You can expand the memory on each machine to a total of 10 MB by installing DRAM SIMMs.

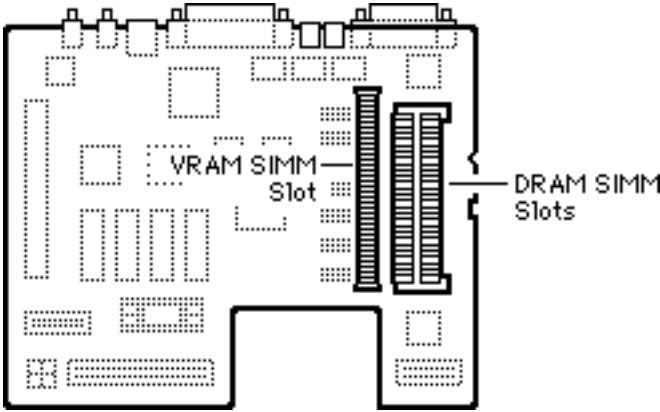

DRAM Configurations	
4 MB	The Performa 400, 405, 410, and 430 logic boards have 4 MB of soldered DRAM.
6 MB	Install two 1 MB SIMMs.
8 MB	Install two 2 MB SIMMs.
10 MB	Install two 4 MB SIMMs (see Note).

Note: The Performa 400, 405, 410, and 430 can address a maximum of 10 MB of DRAM. When you install 4 MB SIMMs, the lower 2 MB of memory on the logic board can't be addressed.

VRAM Configurations	
256K	Install one 256K VRAM SIMM.
512K	Install one 512K VRAM SIMM.

Memory Information	
DRAM Speed	100 ns
SIMM Type	30-pin
Soldered DRAM	4 MB
Number of SIMM Slots	2
Supported Sizes in MB	1, 2, 4
Maximum DRAM	10 MB
Virtual Memory	1 GB
Soldered VRAM	None
Number of VRAM Slots	1

Note: You must fill both slots with matching DRAM SIMMs when upgrading memory.





Performa 450, 460, 466, 467

The Performa 450, 460, 466, and 467 each have 4 MB of soldered DRAM. You can expand the memory of each machine to a total of 36 MB by installing DRAM SIMMs.

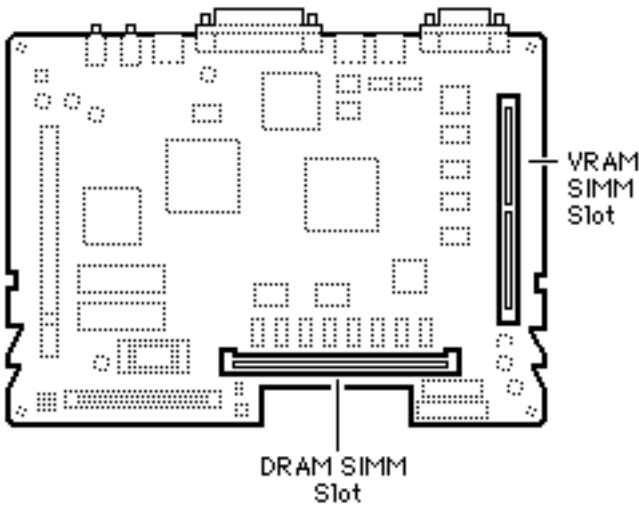

DRAM Configurations	
4 MB	The Performa 450, 460, 466, and 467 logic boards have 4 MB of soldered DRAM.
6 MB	Install one 2 MB SIMM.
8 MB	Install one 4 MB SIMM.
12 MB	Install one 8 MB SIMM.
20 MB	Install one 16 MB SIMM.
36 MB	Install one 32 MB SIMM.

Memory Information	
DRAM Speed	80 ns
SIMM Type	72-pin
Soldered DRAM	4 MB
Number of SIMM Slots	1
Supported Sizes in MB	1, 2, 4, 8, 16, 32
Maximum DRAM	36 MB
Virtual Memory	1 GB
Soldered VRAM	512K
Number of VRAM Slots	1

VRAM Configurations	
512K	The Performa 450, 460, 466, and 467 logic boards have 512K of soldered VRAM.
768K	Install one 256K VRAM SIMM.
1 MB	Install one 512K VRAM SIMM.





Performa 475, 476

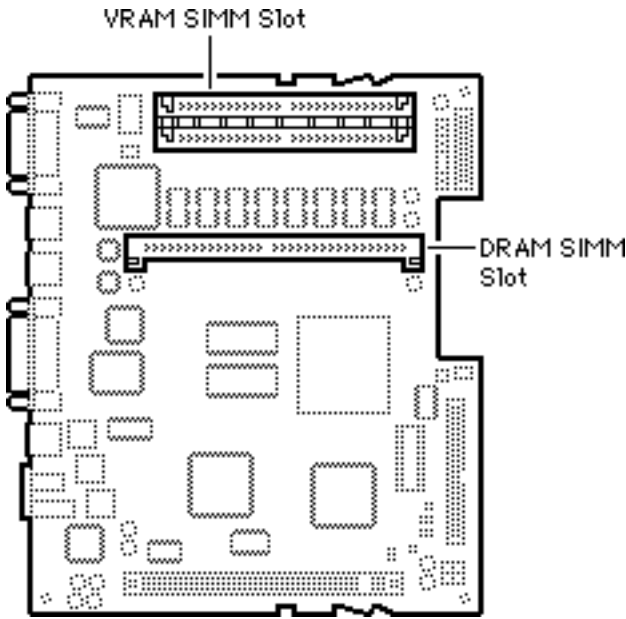

The Performa 475 and 476 each have 4 MB of soldered DRAM. You can expand the memory of each machine to a total of 36 MB by installing DRAM SIMMs.

Single-sided SIMMs in 1, 4, 8, and 16 MB densities are supported, and double-sided SIMMs in 2, 4, and 32 MB densities are also supported.

DRAM Configurations	
4 MB	The Performa 475 and 476 logic boards have 4 MB of soldered DRAM.
5 MB	Install one 1 MB SIMM.
6 MB	Install one 2 MB SIMM.
8 MB	Install one 4 MB SIMM.
12 MB	Install one 8 MB SIMM.
20 MB	Install one 16 MB SIMM.
36 MB	Install one 32 MB SIMM.

Memory Information	
DRAM Speed	80 ns
SIMM Type	72-pin
Soldered DRAM	4 MB
Number of SIMM Slots	1
Supported Sizes in MB	1, 2, 4, 8, 16, 32
Maximum DRAM	36 MB
Virtual Memory	1 GB
Soldered VRAM	(See VRAM Note)
Number of VRAM Slots	2

VRAM Configurations	
512K	Install two 256K VRAM SIMMs.
1 MB	Install two 512K VRAM SIMMs.

VRAM Note: These computers come standard with two 256K VRAM SIMMs installed. You can upgrade the machine to 1 MB of VRAM by replacing the 256K SIMMs with two 512K, 68-pin, 80 ns VRAM SIMMs.





Performa 550, 560

The Performa 550 and Performa 560 logic boards each have 4 MB of soldered DRAM and one 1 MB DRAM SIMM installed. You can expand the memory of each machine to a total of 36 MB by installing additional DRAM SIMMs.

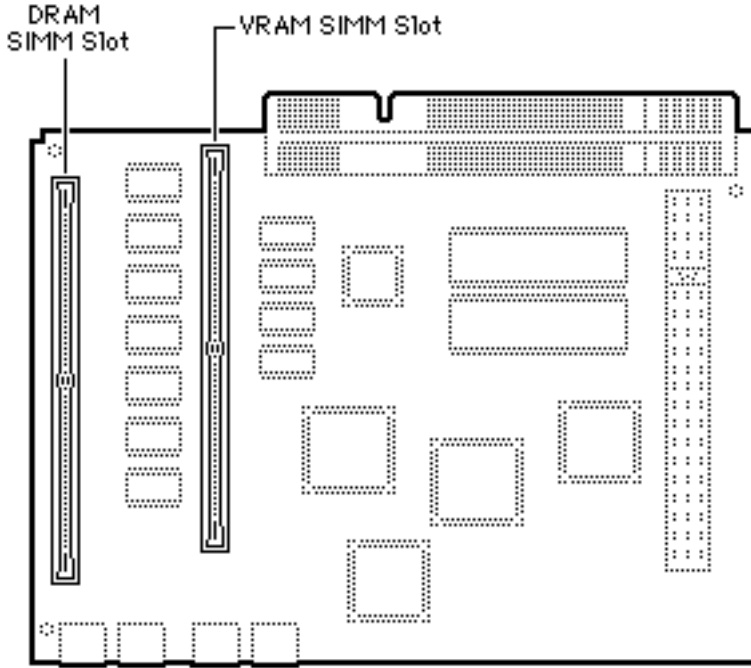

DRAM Configurations	
4 MB	The Performa 550 and 560 logic boards have 4 MB of soldered DRAM.
5 MB	Install one 1 MB SIMM.
6 MB	Install one 2 MB SIMM.
8 MB	Install one 4 MB SIMM.
12 MB	Install one 8 MB SIMM.
20 MB	Install one 16 MB SIMM.
36 MB	Install one 32 MB SIMM.

Memory Information	
DRAM Speed	80 ns
SIMM Type	72-pin
Soldered DRAM	4 MB
Number of SIMM Slots	1
Supported Sizes in MB	1, 2, 4, 8, 16, 32
Maximum DRAM	36 MB
Virtual Memory	1 GB
Soldered VRAM	512K
Number of VRAM Slots	1

VRAM Configurations	
512K	The Performa 550 and 560 logic boards have 512K of soldered VRAM.
768K	Install one 256K VRAM SIMMs.

Note: Some configurations may come with 768K of VRAM already installed. You can verify this by checking the number of available colors under the monitors control panel. If Thousands of colors are available, the maximum VRAM is installed.





Performa 575, 577

The Performa 575 and Performa 577 logic boards each have 4 MB of soldered DRAM. You can expand the memory of each machine to a total of 36 MB by installing DRAM SIMMs.

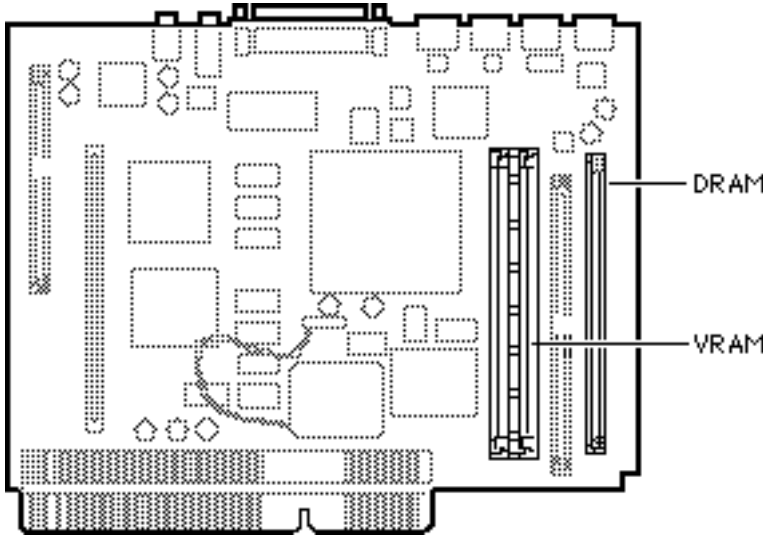

DRAM Configurations	
4 MB	The LC 575 and 577 logic boards each have 4 MB of soldered DRAM.
5 MB	Install one 1 MB SIMM.
6 MB	Install one 2 MB SIMM.
8 MB	Install one 4 MB SIMM.
12 MB	Install one 8 MB SIMM.
20 MB	Install one 16 MB SIMM.
36 MB	Install one 32 MB SIMM.

Memory Information	
DRAM Speed	80 ns
SIMM Type	72-pin
Soldered DRAM	4 MB
Number of SIMM Slots	1
Supported Sizes in MB	1, 4, 16
Maximum RAM	36 MB
Virtual Memory	1 GB
Soldered VRAM	(See VRAM Note)
Number of VRAM Slots	2

VRAM Configurations	
1 MB	Install two 512K VRAM SIMMs.

VRAM Note: The Performa 575 and 577 each come with two 512K VRAM SIMMs installed. VRAM is not upgradeable.





Performa 578

The Performa 578 logic board has 8 MB of DRAM, 4 of which are soldered to the logic board. You can expand the memory to a total of 36 MB by installing DRAM SIMMs.

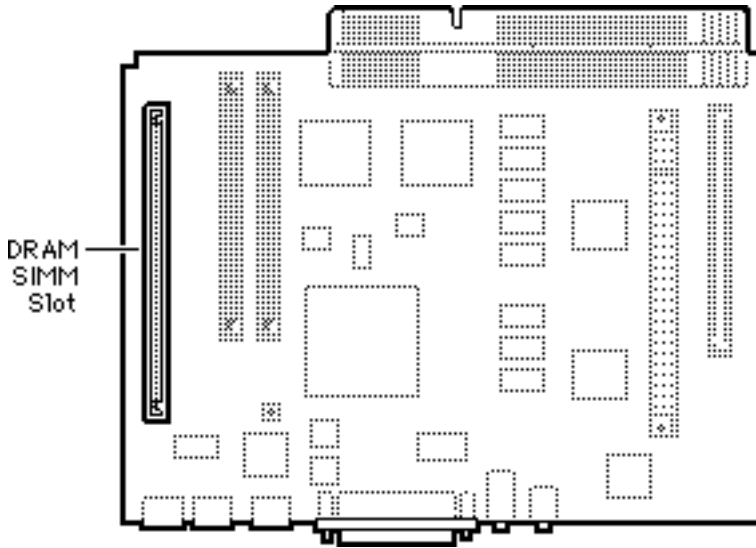

DRAM Configurations	
8 MB	The Performa 578 logic board comes with 4 MB of soldered DRAM and one 4 MB SIMM.
Up to 36 MB	Use 1, 2, 4, 8, 16, or 32 MB 72-pin SIMMs.

Memory Information	
DRAM Speed	80 ns
SIMM Type	72-pin
Soldered DRAM	4 MB
Number of SIMM Slots	1
Supported Sizes in MB	1, 2, 4, 8, 16, 32 MB
Maximum DRAM	36 MB
Virtual Memory	1 GB
Soldered VRAM	None
Number of VRAM Slots	2

VRAM Configurations	
1 MB	Install two 512K VRAM SIMMs.

Note: The Performa 578 comes with two 512K VRAM SIMMs installed. VRAM is not upgradeable.





Performa 580CD

The Performa 580CD logic board has 4 MB of soldered DRAM and is expandable to 52 MB.

The leftmost SIMM slot (as pictured here) can accommodate a single-sided or double-sided 1, 2, 4, 8, 16, or 32 MB SIMM.

The rightmost SIMM slot (as pictured here) can accept only a single-sided 1, 4, or 16 MB SIMM.

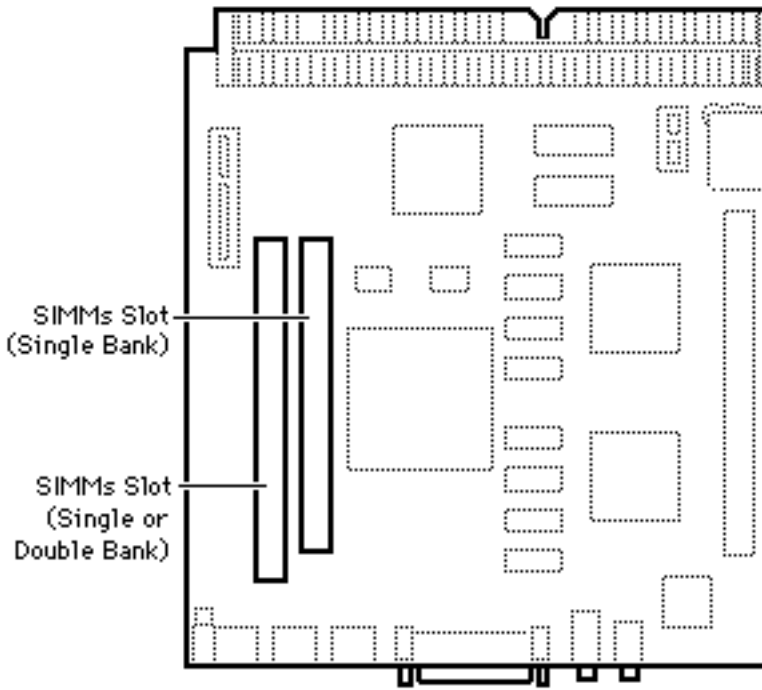

DRAM Configurations	
Up to 52 MB	Use various combinations of 72-pin SIMMs.

Note: The SIMM slots are also marked on the logic board as to which is the slot for the single-sided SIMM.

Memory Information	
DRAM Speed	80 ns
SIMM Type	72-pin
Soldered DRAM	4 MB
Number of SIMM Slots	2
Supported Sizes in MB	See Note
Maximum RAM	52MB
Virtual Memory	1 GB
Soldered VRAM	1 MB
Number of VRAM Slots	None

Note: Supported memory configurations include 6, 7, 9, 10, 12, 13, 46, 21, 22, 24, 28, 36, 37, 40, and 52 MB.





Performa 600

The Performa 600 has 4 MB soldered on and is expandable to 68 MB

Note: A total of 5 MB of memory (soldered DRAM plus one 1 MB SIMM) is standard on the Performa 600.

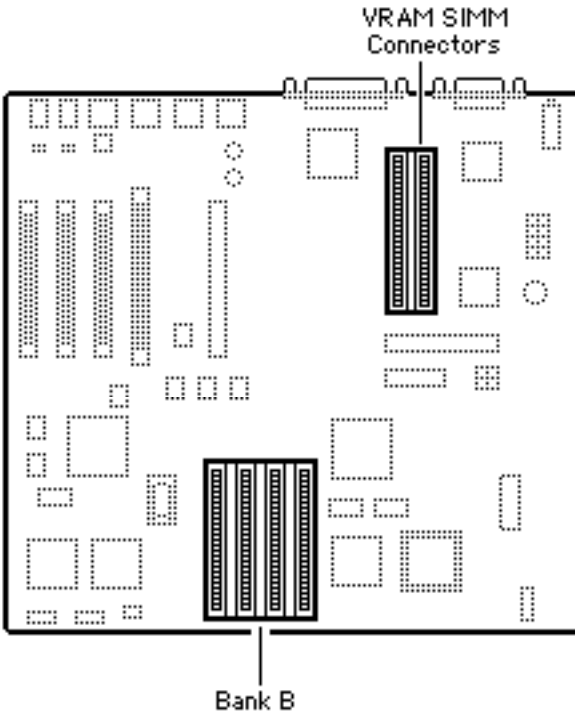

DRAM Configurations		
Total Memory	Bank A (soldered)	Bank B
4 MB	4 MB	Empty
5 MB	4 MB	four 256K
8 MB	4 MB	four 1 MB
12 MB	4 MB	four 2 MB
20 MB	4 MB	four 4 MB
68 MB	4 MB	four 16 MB

Note: You must fill an entire bank of four SIMMs when upgrading.

Memory Information	
DRAM Speed	80 ns
SIMM Type	30-pin
Soldered DRAM	4 MB
Number of SIMM Slots	4
Supported Sizes in MB	.256, 1, 2, 4, 16
Maximum DRAM	68 MB
Virtual Memory	1 GB
Soldered VRAM	None
Number of VRAM Slots	2

VRAM Configurations	
512K	Install two 256K VRAM SIMMs.
1 MB	Install two 512K VRAM SIMMs.





Performa 630, 636

The Performa 630 and Performa 636 have 4 MB of soldered DRAM and are expandable to 36 MB of memory.

Note: The Performa 63x and Quadra 630 cpus may have one of two logic boards. One logic board has one SIMM slot (661-0518), the other logic board (661-1114) has two SIMM slots; a regular SIMM slot and a "single-sided" SIMM slot; expandable to 52 MB.

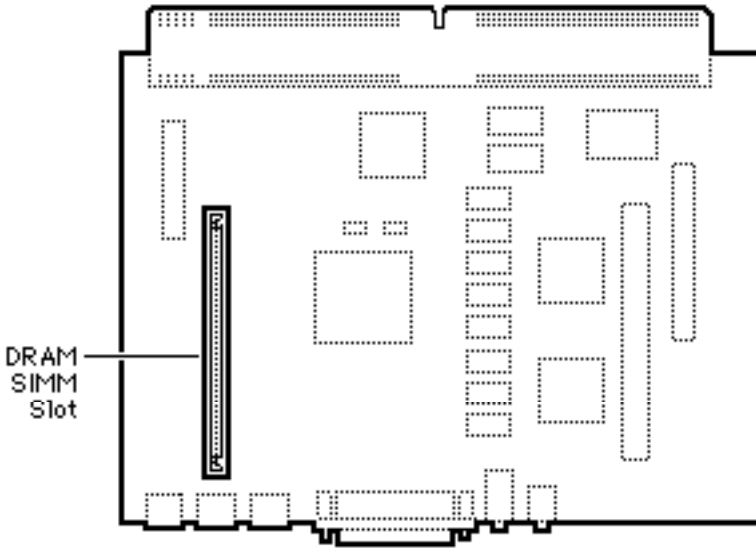

DRAM Configurations	
4 MB	The Performa 630 and Performa 636 logic boards have 4 MB of soldered DRAM.
Up to 36 MB	Use 1, 2, 4, 8, 16, or 32 MB 72-pin SIMMs.
Up to 52 MB	Note: If the customer has the logic board with two SIMM slots (661-1114), the maximum RAM would be 52 MB. To upgrade to 52 MB use a 32 MB SIMM in the regular SIMM slot, and a 16 MB SIMM in the single-sided SIMM slot.

Memory Information	
DRAM Speed	80 ns
SIMM Type	72-pin
Soldered DRAM	4 MB
Number of SIMM Slots	1 or 2 (see Note above)
Supported Sizes in MB	1, 2, 4, 8, 16, 32, 52 MB (see Note above)
Maximum DRAM	36 MB, 52 MB (see Note above)
Virtual Memory	1 GB
Soldered VRAM	1 MB
Number of VRAM Slots	None





Performa 635 CD

The Performa 635 CD logic board has 4 MB of soldered DRAM and is expandable to 36 MB.

Note: The Performa 63x and Quadra 630 cpus may have one of two logic boards. One logic board has one SIMM slot (661-0518), the other logic board (661-1114) has two SIMM slots; a regular SIMM slot and a "single-sided" SIMM slot; expandable to 52 MB.

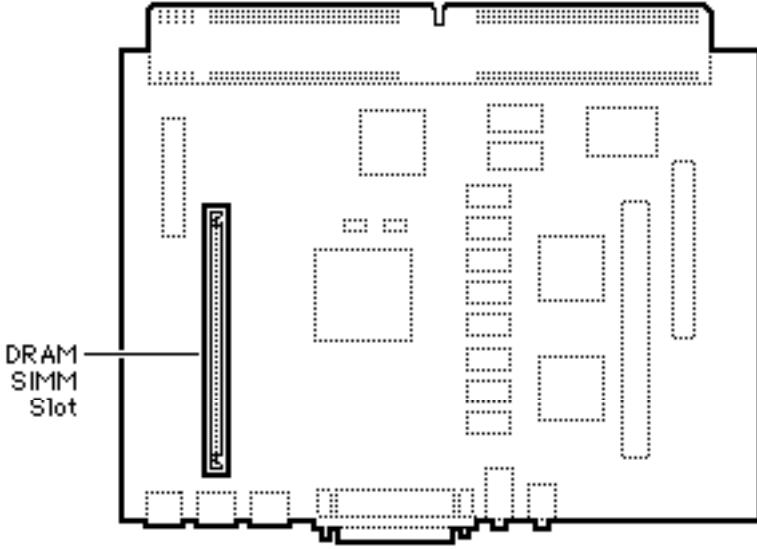

DRAM Configurations	
5 MB	The Performa 635 logic board has 4 MB of soldered DRAM.
36 MB	Use 1, 2, 4, 8, 16, or 32 MB 72-pin SIMMs.
Up to 52 MB	Note: If the customer has the logic board with two SIMM slots (661-1114), the maximum RAM would be 52 MB. To upgrade to 52 MB use a 32 MB SIMM in the regular SIMM slot, and a 16 MB SIMM in the single-sided SIMM slot.

Memory Information	
DRAM Speed	80 ns
SIMM Type	72-pin
Soldered DRAM	4 MB
Number of SIMM Slots	1 or 2 (see Note above)
Supported Sizes in MB	1, 2, 4, 8, 16, 32, 52 MB (see Note above)
Maximum DRAM	36 MB, 52 MB (see Note above)
Virtual Memory	1 GB
Soldered VRAM	1 MB
Number of VRAM Slots	None





Performa 630 CD, 637 CD, 638 CD

All models have 4 MB of soldered DRAM and are expandable to 36 MB.

Note: The Performa 63x and Quadra 630 cpus may have one of two logic boards. One logic board has one SIMM slot (661-0518), the other logic board (661-1114) has two SIMM slots; a regular SIMM slot and a "single-sided" SIMM slot; expandable to 52 MB.

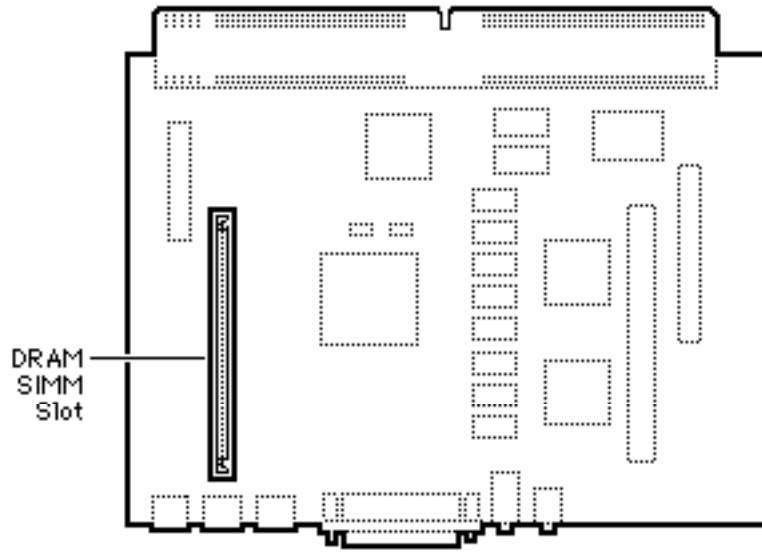

DRAM Configurations	
4 MB	The Performa 630 CD, Performa 637 CD, and Performa 638 CD logic boards have 4 MB of soldered DRAM.
36 MB	Use 1, 2, 4, 8, 16, or 32 MB 72-pin SIMMs.
Up to 52 MB	Note: If the customer has the logic board with two SIMM slots (661-1114), the maximum RAM would be 52 MB. To upgrade to 52 MB use a 32 MB SIMM in the regular SIMM slot, and a 16 MB SIMM in the single-sided SIMM slot.

Memory Information	
DRAM Speed	80 ns
SIMM Type	72-pin
Soldered DRAM	4 MB
Number of SIMM Slots	1 or 2 (see Note above)
Supported Sizes in MB	1, 2, 4, 8, 16, 32, 52 MB (see Note above)
Maximum DRAM	36 MB, 52 MB (see Note above)
Virtual Memory	1 GB
Soldered VRAM	1 MB
Number of VRAM Slots	None





Performa 640

The Performa 640 has 8 MB of DRAM: 4 MB soldered and a 4 MB SIMM in one slot. Up to 52 MB is available (4 MB soldered, 32 MB in one SIMM slot, and 16 MB in the other SIMM slot on the DOS Card). The DOS Compatible board has a 4 MB SIMM installed and is expandable to 32 MB.

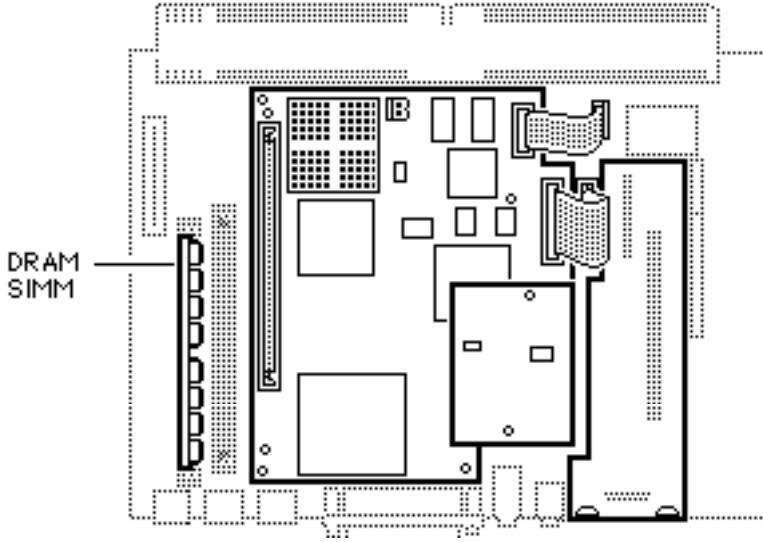

DRAM Configurations	
8 MB	The Performa 640 has 8 MB of DRAM: 4 MB soldered, 4 MB SIMM in one slot.
52 MB	Use various combinations up to 52 MB of 72-pin SIMMs.

Memory Information	
DRAM Speed	80 ns
SIMM Type	72-pin
Soldered DRAM	4 MB
Number of SIMM Slots	1
Supported Sizes in MB	1, 2, 4, 8, 16, 32
Maximum DRAM	36 MB
Virtual Memory	1 GB
Soldered VRAM	1 MB
Number of VRAM Slots	None





Performa 5200CD, 5215CD and 5300CD

The Performa 5200CD, 5215CD, and 5300CD computers have no soldered DRAM. You can expand the total memory up to a maximum of 64 MB by installing DRAM SIMMs.

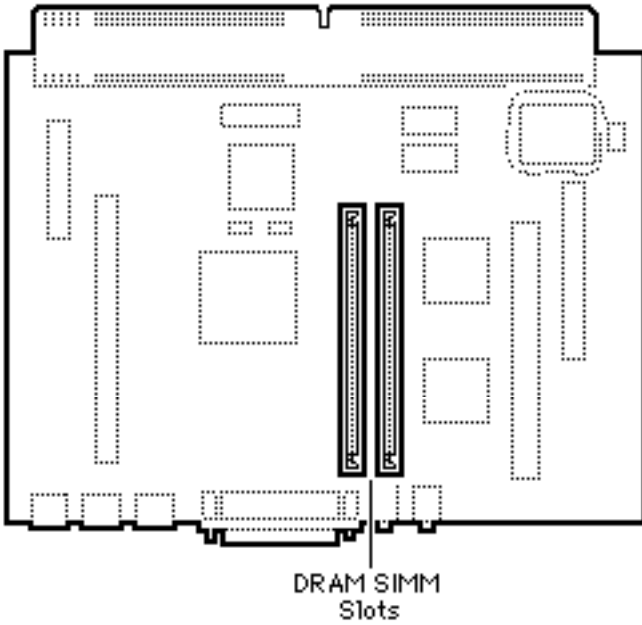

DRAM Configurations	
8 MB	The Performa 5200CD, 5215CD, and 5300CD have a minimum of 8 MB of DRAM.
Up to 64 MB	Use various combinations up to 64 MB of 72-pin SIMMs.

Note: The Performa 5200 Series computers have two SIMM slots. You do not have to fill both slots when upgrading memory, nor do you have to use SIMMs of the same size.

Note: Supported memory configurations include 8, 12, 16, 20, 24, 32, 36, 40, 48, and 64 MB.

Memory Information	
DRAM Speed	80 ns
SIMM Type	72-pin
Soldered DRAM	None
Number of SIMM Slots	2
Supported Sizes in MB	4, 8, 16, 32
Maximum DRAM	64 MB
Virtual Memory	1 GB
Soldered VRAM	1 MB
Number of VRAM Slots	None





Performa 5320CD

The Performa 5320CD computer has no soldered DRAM. You can expand the total memory up to a maximum of 64 MB by installing DRAM SIMMs.

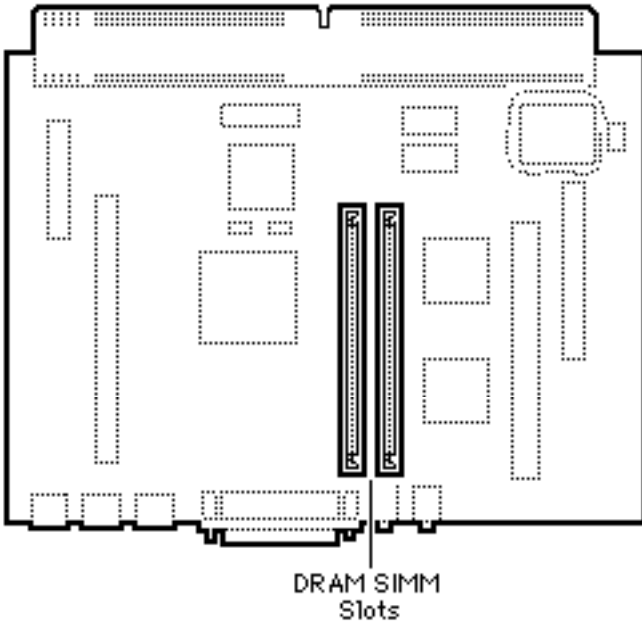

DRAM Configurations	
8 MB	The Performa 5200CD, 5215CD, and 5300CD have a minimum of 8 MB of DRAM.
Up to 64 MB	Use various combinations up to 64 MB of 72-pin SIMMs.

Note: The Performa 5320CD computer has two SIMM slots. You do not have to fill both slots when upgrading memory, nor do you have to use SIMMs of the same size.

Note: Supported memory configurations include 8, 12, 16, 20, 24, 32, 36, 40, 48, and 64 MB.

Memory Information	
DRAM Speed	80 ns
SIMM Type	72-pin
Soldered DRAM	None
Number of SIMM Slots	2
Supported Sizes in MB	4, 8, 16, 32
Maximum DRAM	64 MB
Virtual Memory	1 GB
Soldered VRAM	1 MB
Number of VRAM Slots	None



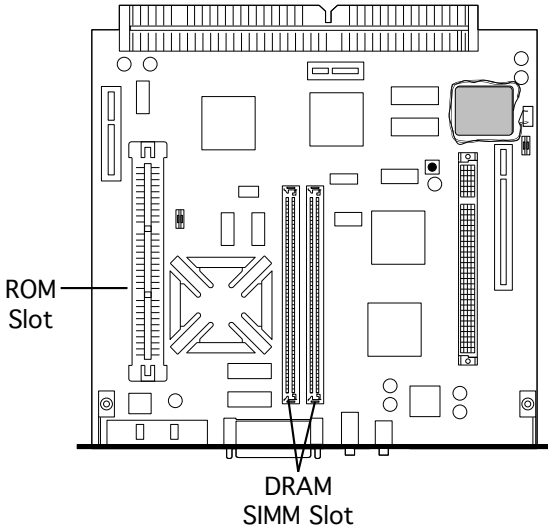

Performa 5260/120 and 5280

The Performa 5260/120 and 5280 come standard with 16 MB of DRAM. You can expand the total memory up to a maximum of 64 MB by installing DRAM SIMMs.

DRAM Configurations	
16 MB	The Performa 5260/120 has a minimum of 16 MB of DRAM.
Up to 64 MB	Use various combinations up to 64 MB of 72-pin SIMMs.

Note: The Performa 5260/120 computer has two SIMM slots. You do not have to fill both slots when upgrading memory, nor do you have to use SIMMs of the same size.

Note: Supported memory configurations include 16, 20, 24, 32, 36, 40, 48, and 64 MB.

Memory Information	
DRAM Speed	80 ns
SIMM Type	72-pin
Soldered DRAM	None
Number of SIMM Slots	2
Supported Sizes in MB	4, 8, 16, 32
Maximum DRAM	64 MB
Virtual Memory	1 GB
Soldered VRAM	1 MB
Number of VRAM Slots	None





Performa 5400 Series

The information presented here is valid for Performa 5400/160, 5400/180, 5420, and 5420/180 computers. These are international computers that come standard with 16 MB of DRAM. You can expand the total memory up to a maximum of 136 MB by installing DRAM DIMMs.

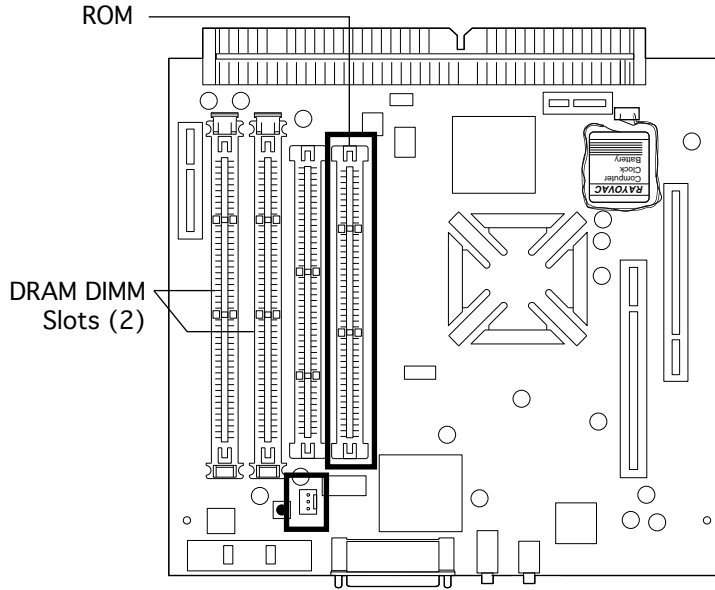

DRAM Configurations	
16 MB	The Performa 5400 Series computers have a minimum of 16 MB of DRAM.
Up to 136 MB	Use various combinations up to 136 MB of 168-pin DIMMs.

Note: The Performa 5400 Series computers have two DIMM slots. You do not have to fill both slots when upgrading memory, nor do you have to use DIMMs of the same size.

Note: Supported memory configurations include 16, 20, 24, 32, 36, 40, 48, 64, and 136 MB.

Note: These computers require 2K refresh rate DIMMs

Memory Information	
DRAM Speed	70 ns
DIMM Type	168-pin, 2K refresh
Soldered DRAM	16 MB
Number of DIMM Slots	2
Supported Sizes in MB	4, 8, 16, 32, 64
Maximum DRAM	136 MB
Virtual Memory	1 GB
Soldered VRAM	1 MB
Number of VRAM Slots	None





Performa 6100 Series

The Performa 6110 CD, 6112 CD, 6115 CD, 6117 CD, and 6118 CD logic boards have 8 MB of soldered DRAM and are expandable to 72 MB.

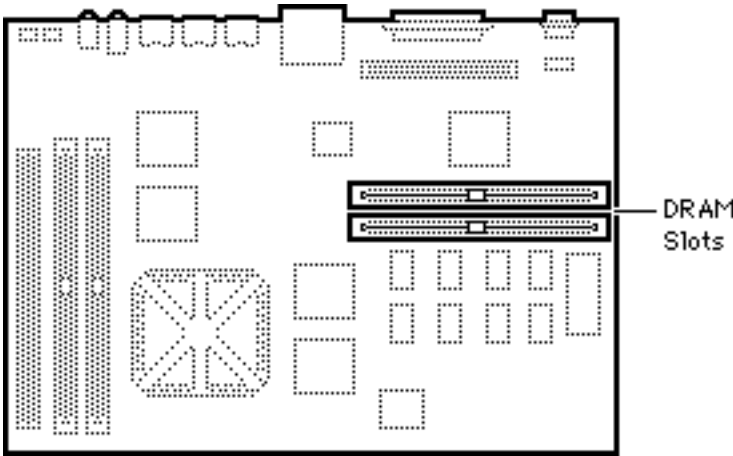

DRAM Configurations	
8 MB	The Performa 6110 CD, 6112 CD, 6115 CD, 6117 CD, and 6118 CD logic boards have 8 MB of soldered DRAM.
72 MB	Use a pair of 72-pin SIMMs for total configurations up to 72 MB

Memory Information	
DRAM Speed	80 ns
SIMM Type	72-pin
Soldered DRAM	8 MB
Number of SIMM Slots	2
Supported Sizes in MB	4, 8, 16, 32
Maximum DRAM	72 MB
Virtual Memory	1 GB
Soldered VRAM	None
Number of VRAM Slots	None

Note: SIMMs must be installed in matching pairs. Install noncomposite SIMMs only.





Performa 6200 Series

The Performa 6200 Series computers have no soldered DRAM. You can expand the total memory up to a maximum of 64 MB by installing DRAM SIMMs.

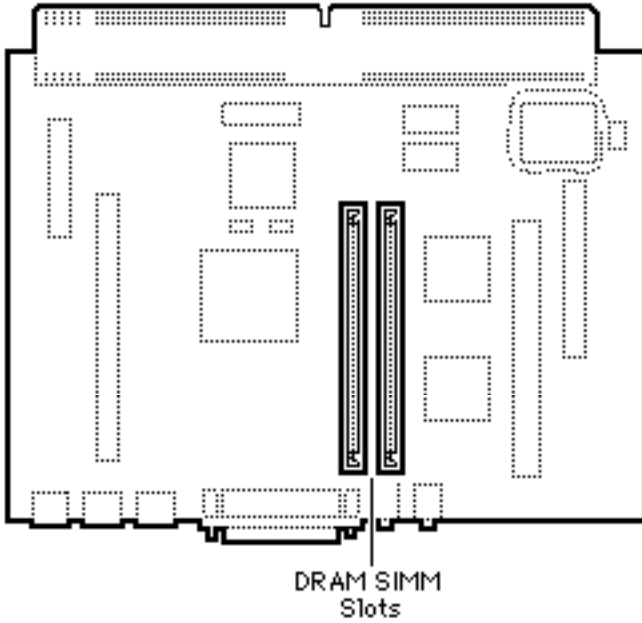

DRAM Configurations	
8 MB	The Performa 6200 has a minimum of 8 MB of DRAM.
Up to 64 MB	Use various combinations up to 64 MB of 72-pin SIMMs.

Note: The Performa 6200 Series computers have two SIMM slots. You do not have to fill both slots when upgrading memory, nor do you have to use SIMMs of the same size.

Note: Supported memory configurations include 8, 12, 16, 20, 24, 32, 36, 40, 48, and 64 MB.

Memory Information	
DRAM Speed	80 ns
SIMM Type	72-pin
Soldered DRAM	None
Number of SIMM Slots	2
Supported Sizes in MB	4, 8, 16, 32
Maximum DRAM	64 MB
Virtual Memory	1 GB
Soldered VRAM	1 MB
Number of VRAM Slots	None





Performa 6300 Series (except 6360)

The Performa 6300 Series computers (excluding the 6360) ship with a minimum of 16 MB of DRAM. You can expand the total memory up to a maximum of 64 MB by installing DRAM SIMMs.

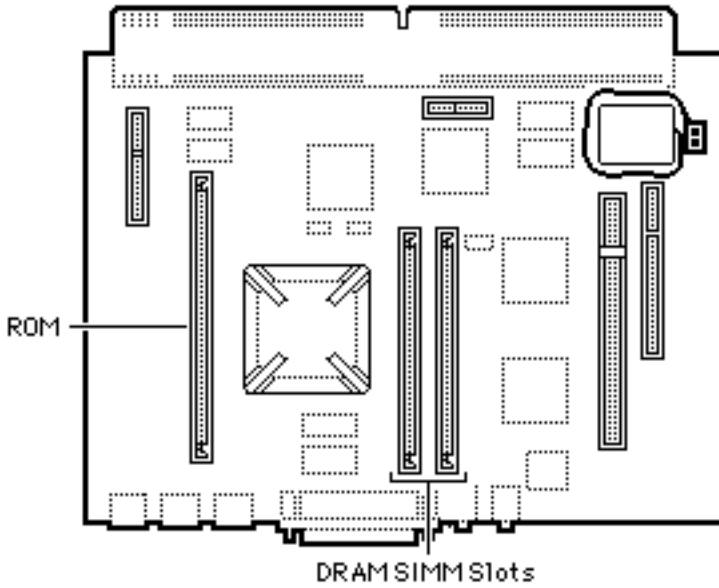

DRAM Configurations	
16 MB	The Performa 6300 Series computers have a minimum of 16 MB of DRAM.
Up to 64 MB	Use various combinations up to 64 MB of 72-pin SIMMs.

Note: The Performa 6300 Series computers have two SIMM slots. You do not have to fill both slots when upgrading memory, nor do you have to use SIMMs of the same size.

Note: Supported memory configurations include 16, 20, 24, 32, 36, 40, 48, and 64 MB.

Memory Information	
DRAM Speed	80 ns
SIMM Type	72-pin
Soldered DRAM	None
Number of SIMM Slots	2
Supported Sizes in MB	4, 8, 16, 32
Maximum DRAM	64 MB
Virtual Memory	1 GB
Soldered VRAM	1 MB
Number of VRAM Slots	None





Performa 6360

The Performa 6360 ships with a minimum of 16 MB of DRAM. You can expand the total memory up to a maximum of 136 MB by installing DRAM DIMMs.

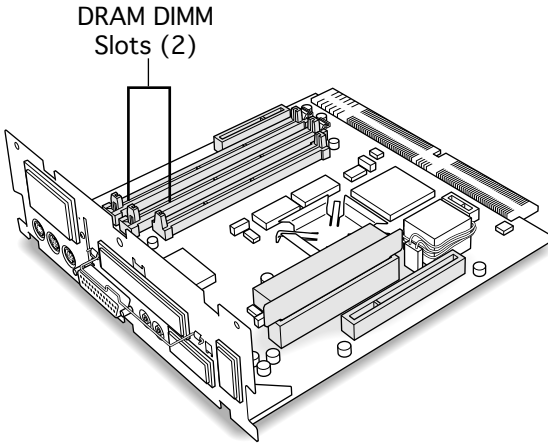

DRAM Configurations	
16 MB	The Performa 6360 comes standard with a minimum of 16 MB of DRAM.
Up to 136 MB	Use various combinations up to 136 MB of 168-pin DIMMs.

Note: The Performa 6360 has two DIMM slots. You do not have to fill both slots when upgrading memory, nor do you have to use DIMMs of the same size.

Note: Supported memory configurations include 16, 20, 24, 32, 36, 40, 48, 64, and 136 MB.

Memory Information	
DRAM Speed	70 ns
DIMM Type	168-pin
Soldered DRAM	8 MB
Number of DIMM Slots	2
Supported Sizes in MB	4, 8, 16, 32, 64
Maximum DRAM	136 MB
Virtual Memory	1 GB
Soldered VRAM	1 MB
Number of VRAM Slots	None





Performa 6400

The Performa 6400 ships with a minimum of 16 MB of DRAM. You can expand the total memory up to a maximum of 136 MB by installing DRAM DIMMs.

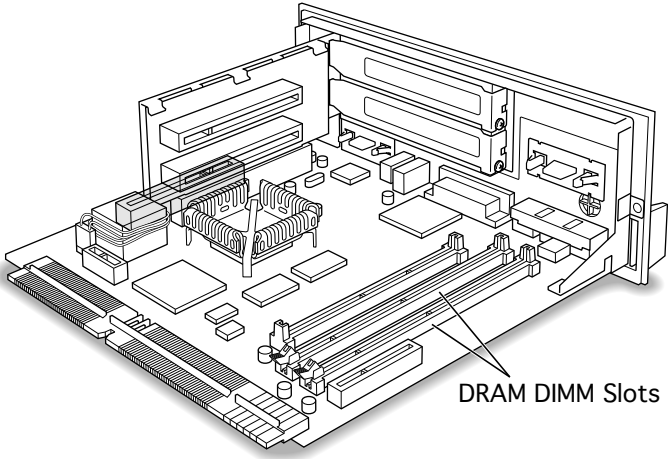

DRAM DIMM Slots

DRAM Configurations	
16 MB	The Performa 6400 comes standard with a minimum of 16 MB of DRAM.
Up to 136 MB	Use various combinations up to 136 MB of 168-pin DIMMs.

Note: The Performa 6400 has two DIMM slots. You do not have to fill both slots when upgrading memory, nor do you have to use DIMMs of the same size.

Note: Supported memory configurations include 16, 20, 24, 32, 36, 40, 48, 64, and 136 MB.

Note: This computer requires 2K refresh rate DIMMs.

Memory Information	
DRAM Speed	70 ns
DIMM Type	168-pin, 2K refresh
Soldered DRAM	8 MB
Number of DIMM Slots	2
Supported Sizes in MB	4, 8, 16, 32, 64
Maximum DRAM	136 MB
Virtual Memory	1 GB
Soldered VRAM	1 MB
Number of VRAM Slots	None





Power Macintosh



Power Macintosh 4400/160

The Power Macintosh 4400/160 has no DRAM soldered onto the logic board. You can expand the amount of memory to a total of 96 MB by installing DRAM DIMMs.

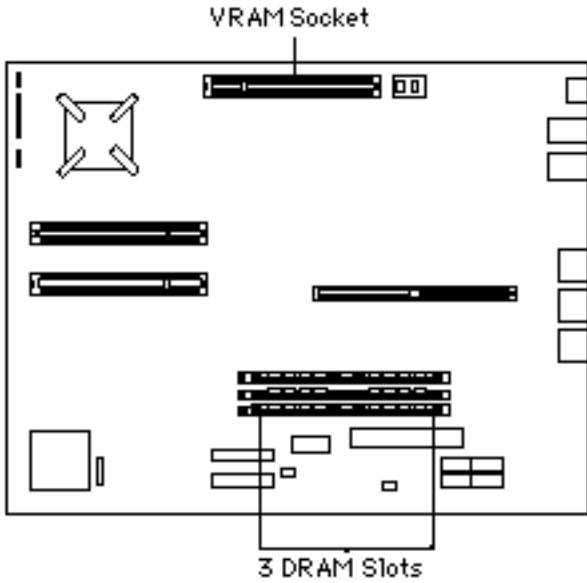

DRAM Configurations	
16 MB	The Power Macintosh 4400/160 logic board has 16 MB of installed DRAM.
Up to 96 MB	Use 4, 8, 16, or 32 MB 168-pin DIMMs.

Note: DRAM DIMMs can be installed one or more at a time. Slot 1 supports only single-bank DIMMs. Slots 2 and 3 support both single-bank and dual-bank DIMMs.

Note: The Single In-Line Memory Modules (SIMMs) used in previous Macintosh models are NOT compatible with the Power Macintosh 4400.

Note: This computer does not have any main memory soldered to the logic board. At least one DRAM DIMM must be installed for the computer to operate.

Note: The PM4400/160 comes with 1 MB of VRAM installed.

Memory Information	
DRAM Speed	60 ns
DIMM Type	168-pin, 3.3 V unbuffered EDO, 1.1 in. high
Soldered DRAM	None
Number of DIMM Slots	3
Supported Sizes in MB	4, 8, 16, 32
Maximum DRAM	96 MB
Virtual Memory	1 GB
Soldered Video RAM	None
Number of Video RAM Slots	1

Note: The logic board has a 120-pin video DIMM connector that allows the use of EDO RAM or SGRAM. The video controller supports the following for video memory:

- 1 or 2 MB of EDO RAM
- 2 or 4 MB of SGRAM





Power Macintosh 4400/200 and 7220/200

The Power Macintosh 4400/200 has no DRAM soldered onto the logic board. You can expand the amount of memory to a total of 160 MB by installing DRAM DIMMs.

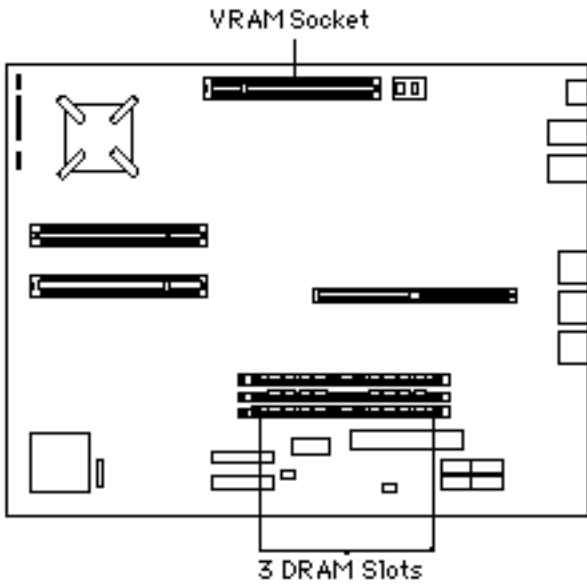

DRAM Configurations	
32 MB	The Power Macintosh 4400/200 logic board has 32 MB of installed DRAM.
Up to 160 MB	Use 4, 8, 16, 32, or 64 MB 168-pin DIMMs.

Note: DRAM DIMMs can be installed one or more at a time. Slot 1 supports only single-bank DIMMs. Slots 2 and 3 support both single-bank and dual-bank DIMMs.

Note: The SIMMs used in previous Macintosh models are NOT compatible with the Power Macintosh 4400.

Note: This computer does not have any main memory soldered to the logic board. At least one DRAM DIMM must be installed for the computer to operate.

Note: The PM 4400/200 comes with 2 MB of VRAM installed.

Note: The logic board has a 120-pin video DIMM connector that allows the use of EDO

Memory Information	
DRAM Speed	60 ns
DIMM Type	168-pin, 3.3 V unbuffered EDO, 1.1 in. high, 1K or 2K refresh
Soldered DRAM	None
Number of DIMM Slots	3
Supported Sizes in MB	4, 8, 16, 32, 64
Maximum DRAM	160 MB
Virtual Memory	1 GB
Soldered Video RAM	None
Number of Video RAM Slots	1

RAM or SGRAM. The video controller supports the following for video memory:

- 1 or 2 MB of EDO RAM
- 2 or 4 MB of SGRAM





Power Macintosh 5200/75 LC

The Power Macintosh 5200/75 LC has no soldered DRAM. You can expand the amount of memory to a total of 64 MB by installing DRAM SIMMs.

The Power Macintosh 5200/75 LC has two SIMM slots. You do not have to fill both slots when upgrading memory, nor do you have to SIMMs of the same size.

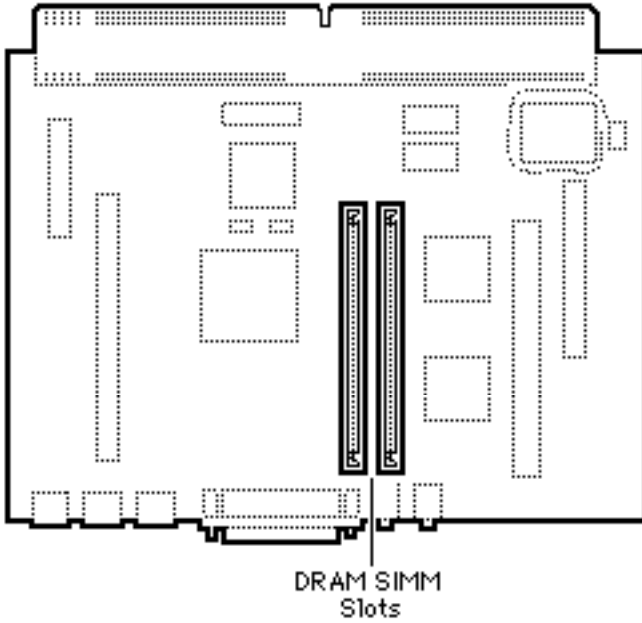

DRAM Configurations	
8 MB	The Power Macintosh 5200/75 LC has a minimum of 8 MB of DRAM.
Up to 64 MB	Use various combinations of 72-pin SIMMs to install up to 64 MB of DRAM.

Note: Supported memory configurations include 8, 12, 16, 20, 24, 32, 36, 40, 48, and 64 MB of DRAM.

Memory Information	
DRAM Speed	70 ns
SIMM Type	72-pin
Soldered DRAM	None
Number of SIMM Slots	2
Supported Sizes in MB	4, 8, 16, 32
Maximum DRAM	64 MB
Virtual Memory	1 GB
Soldered VRAM	1 MB
Number of VRAM Slots	None



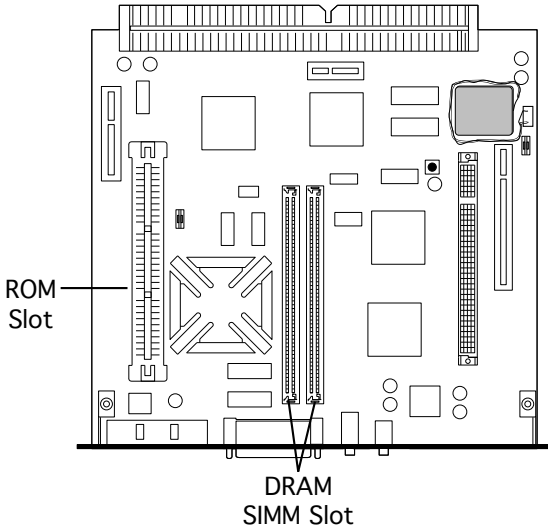

Power Macintosh 5260/100 and 5260/120

The Power Macintosh 5260/100 and 5260/120 come standard with 16 MB of DRAM. You can expand the total memory up to a maximum of 64 MB by installing DRAM SIMMs.

DRAM Configurations	
16 MB	The Power Macintosh 5260/100 and 5260/120 have a minimum of 16 MB of DRAM.
Up to 64 MB	Use various combinations up to 64 MB of 72-pin SIMMs.

Note: The Power Macintosh 5260 computer has two SIMM slots. You do not have to fill both slots when upgrading memory, nor do you have to use SIMMs of the same size.

Note: Supported memory configurations include 16, 20, 24, 32, 36, 40, 48, and 64 MB.

Memory Information	
DRAM Speed	80 ns
SIMM Type	72-pin
Soldered DRAM	None
Number of SIMM Slots	2
Supported Sizes in MB	4, 8, 16, 32
Maximum DRAM	64 MB
Virtual Memory	1 GB
Soldered VRAM	1 MB
Number of VRAM Slots	None





Power Macintosh 5300/100 LC

The Power Macintosh 5300/100 LC has no soldered DRAM. You can expand the amount of memory to a total of 64 MB by installing DRAM SIMMs.

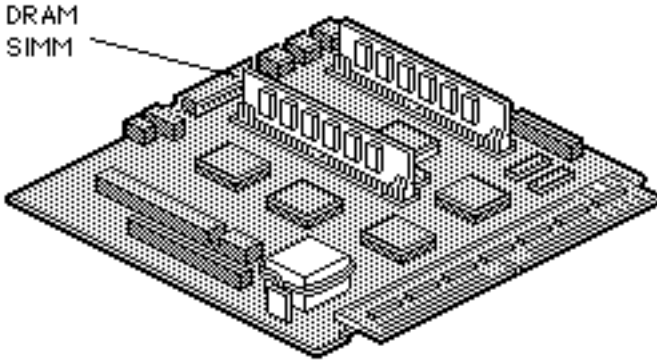

DRAM Configurations	
Up to 64 MB	Use various sizes of 72-pin SIMMs to expand to a total of 64 MB of DRAM.

Note: You must remove the heat sink on the 5300 series logic board to install or replace a SIMM in the slot next to the processor.

Note: On the back (tracing side) of the logic board, pry off the four corner tabs of the heat sink. Remove the heat sink from the component side of the logic board, then install the SIMM. Be sure to replace the heat sink after the memory upgrade.

Memory Information	
DRAM Speed	80 ns
SIMM Type	72-pin
Soldered DRAM	None
Number of SIMM Slots	2
Supported Sizes in MB	4, 8, 16, 32
Maximum DRAM	64 MB
Virtual Memory	1 GB
Soldered VRAM	1 MB DRAM
Number of VRAM Slots	None





Power Macintosh 5400/120 and 5400/180

The Power Macintosh 5400/120 and 5400/180 computers come standard with 16 MB of DRAM. You can expand the total memory up to a maximum of 136 MB by installing DRAM DIMMs.

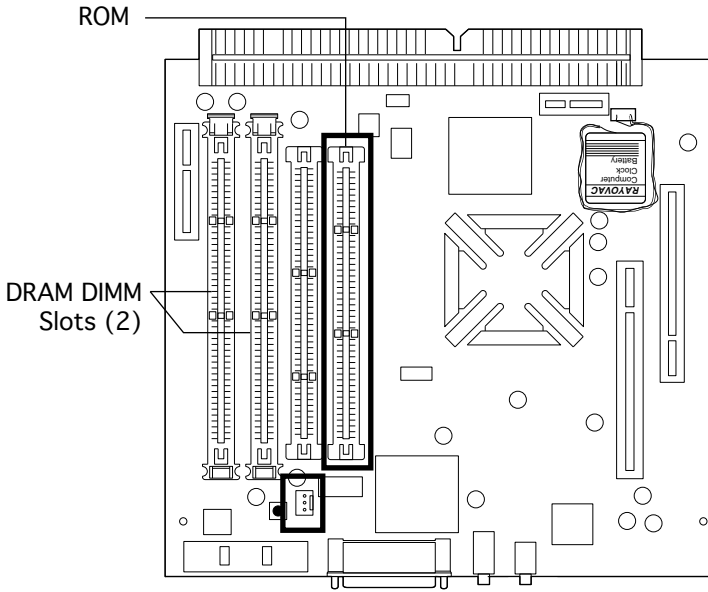

DRAM Configurations	
16 MB	The Power Macintosh 5400/120 and 5400/180 computers have a minimum of 16 MB of DRAM.
Up to 136 MB	Use various combinations up to 136 MB of 168-pin DIMMs.

Note: The Power Macintosh 5400/120 and 5400/180 computers have two DIMM slots. You do not have to fill both slots when upgrading memory, nor do you have to use DIMMs of the same size.

Note: Supported memory configurations include 16, 20, 24, 32, 36, 40, 48, 64, and 136 MB.

Note: This computer requires 2K refresh rate DIMMs

Memory Information	
DRAM Speed	70 ns
DIMM Type	168-pin, 2K refresh
Soldered DRAM	8 MB
Number of DIMM Slots	2
Supported Sizes in MB	4, 8, 16, 32, 64
Maximum DRAM	136 MB
Virtual Memory	1 GB
Soldered VRAM	1 MB
Number of VRAM Slots	None





Power Macintosh 5400/200

The Power Macintosh 5400/200 computer comes standard with 24 MB DRAM (8 MB soldered on board). You can expand the total memory up to a maximum of 136 MB by installing DRAM DIMMs.

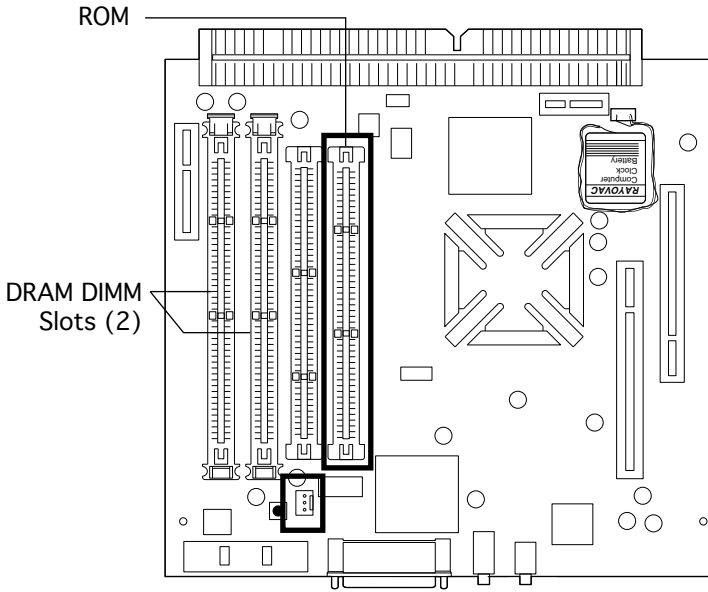

DRAM Configurations	
24 MB	The Power Macintosh 5400/200 computer has a minimum of 24 MB of DRAM.
Up to 136 MB	Use various combinations up to 136 MB of 168-pin DIMMs.

Note: The Power Macintosh 5400/200 computer has two DIMM slots. You do not have to fill both slots when upgrading memory, nor do you have to use DIMMs of the same size.

Note: Supported memory configurations include 16, 20, 24, 32, 36, 40, 48, 64, and 136 MB.

Note: This computer requires 2K refresh rate, 5-volt buffered EDO DIMMs

Memory Information	
DRAM Speed	60 ns
DIMM Type	168-pin, 2K refresh, 5V buffered EDO
Soldered DRAM	8 MB
Number of DIMM Slots	2
Supported Sizes in MB	4, 8, 16, 32, 64
Maximum DRAM	136 MB
Virtual Memory	1 GB
Soldered VRAM	1 MB
Number of VRAM Slots	None





Power Macintosh 5500/225

The Power Macintosh 5500/225 computer comes standard with 32 MB DRAM (no DRAM soldered on board). You can expand the total memory up to a maximum of 128 MB by installing DRAM DIMMs.

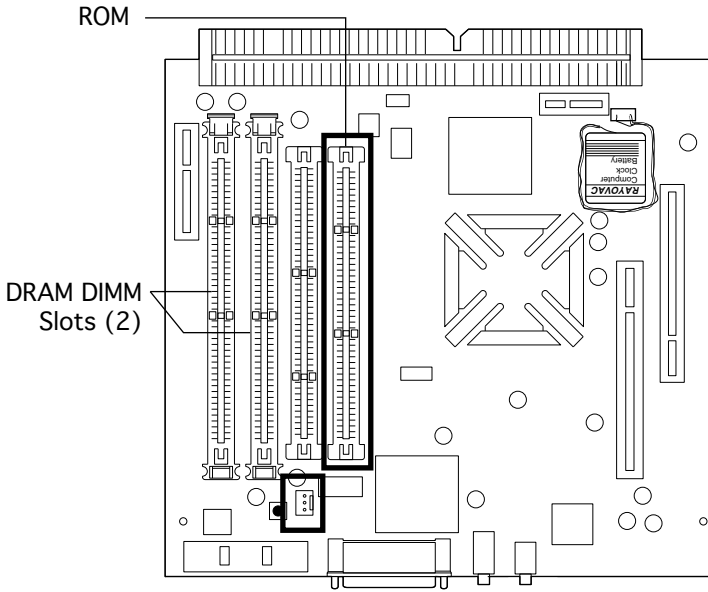

DRAM Configurations	
32 MB	The Power Macintosh 5500/225 computer has a minimum of 32 MB of DRAM.
Up to 128 MB	Use various combinations up to 128 MB of 168-pin DIMMs.

Note: The Power Macintosh 5500/225 computer has two DIMM slots. You do not have to fill both slots when upgrading memory, nor do you have to use DIMMs of the same size.

Note: Supported memory configurations include 16, 20, 24, 32, 36, 40, 48, 64, and 128 MB.

Note: This computer requires 2K refresh rate DIMMs. The 5500 logic board accommodates 5-volt EDO DIMMs.

Memory Information	
DRAM Speed	60 ns
DIMM Type	168-pin, 2K refresh, 5V buffered EDO
Soldered DRAM	None
Number of DIMM Slots	2
Supported Sizes in MB	4, 8, 16, 32, 64
Maximum DRAM	128 MB
Virtual Memory	1 GB
Soldered VRAM	2 MB
Number of VRAM Slots	None





Power Macintosh 6100 Series

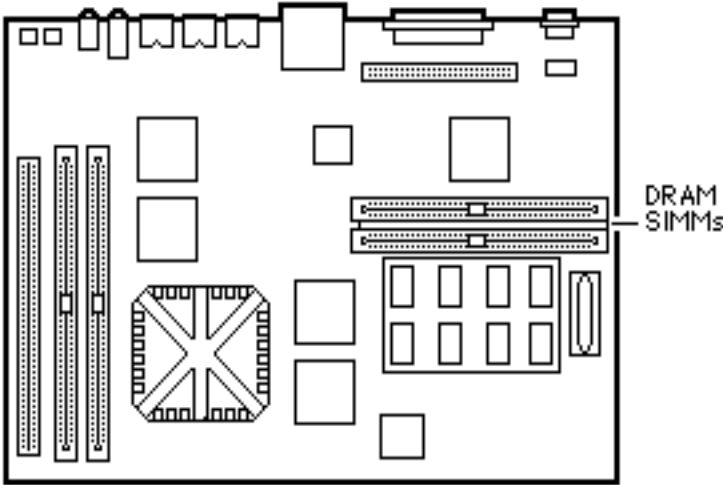

The Power Macintosh 6100 has 8 MB of DRAM soldered onto the logic board. You can expand the amount of memory to a total of 72 MB by installing DRAM SIMMs.

The Power Macintosh 6100 operates in 32-bit mode only and cannot be toggled back to 24-bit mode.

DRAM Configurations	
8 MB	The Power Macintosh 6100 Series logic boards have 8 MB of soldered DRAM.
Up to 72 MB	Use 4, 8, 16, or 32 MB 72-pin SIMMs.

Note: SIMMs must be installed in pairs of the same size or the system will read both SIMMs at the higher density. System crashes are possible in this situation.

Possible DRAM configurations are 8, 16, 24, 40, and 72 MB.

Memory Information	
DRAM Speed	80 ns
SIMM Type	72-pin
Soldered DRAM	8 MB
Number of SIMM Slots	2
Supported Sizes in MB	4, 8, 16, 32
Maximum DRAM	72 MB
Virtual Memory	1 GB
Soldered VRAM	None
Number of VRAM Slots	None
Cache SIMM slot	Yes
Cache SIMM size	128k, 256K





Power Macintosh 6400/180 and 6400/200

The Power Macintosh 6400 ships with a minimum of 16 MB of DRAM. You can expand the total memory up to a maximum of 136 MB by installing DRAM DIMMs.

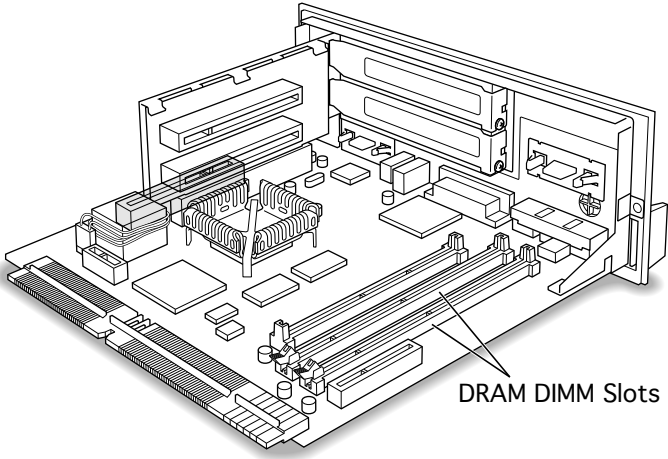

DRAM Configurations	
16 MB	The Power Macintosh 6400 comes standard with a minimum of 16 MB of DRAM.
Up to 136 MB	Use various combinations up to 136 MB of 168-pin DIMMs.

Note: The Power Macintosh 6400 has two DIMM slots. You do not have to fill both slots when upgrading memory, nor do you have to use DIMMs of the same size. However, if you wish to take advantage of the computer's interleaving capability, which provides maximum performance, you must install the DIMMs in matching pairs. DIMMs purchased from different manufacturers can be paired as long as they are the same size and speed.

Note: Supported memory configurations include 16, 20, 24, 32, 36, 40, 48, 64, and 136 MB.

Note: This computer requires 1K or 2K refresh rate EDO DIMMs.

Memory Information	
DRAM Speed	60 ns
DIMM Type	168-pin, 1K or 2K refresh
Soldered DRAM	8 MB
Number of DIMM Slots	2
Supported Sizes in MB	4, 8, 16, 32, 64
Maximum DRAM	136 MB
Virtual Memory	1 GB
Soldered VRAM	1 MB
Number of VRAM Slots	None





Power Macintosh 6500 Series

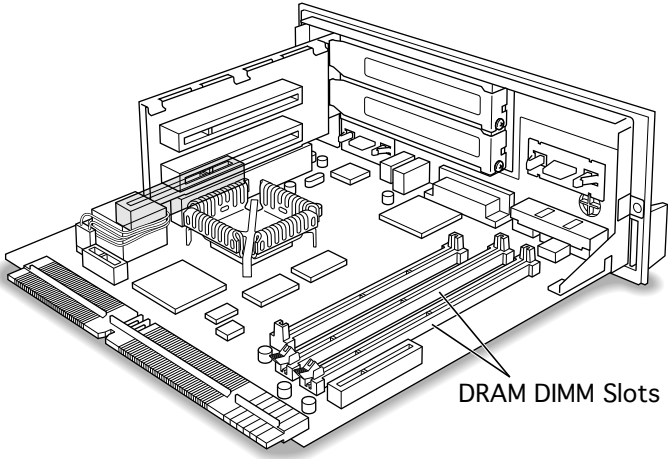

The information presented here is valid for the Power Macintosh 6500/225, 6500/250, 6500/275, and 6500/300. The Power Macintosh 6500 Series ships with a minimum of 32 MB of DRAM. The 6500/ 275 comes with 48 MB and the 6500/300 comes with 64 MB DRAM. You can expand the total memory up to a maximum of 128 MB by installing DRAM DIMMs.

DRAM Configurations	
32 MB	The Power Macintosh 6500 comes standard with a minimum of 32 MB of DRAM.
Up to 128 MB	Use various combinations up to 128 MB of 168-pin DIMMs.

Memory Information	
DRAM Speed	60 ns
DIMM Type	168-pin, 1K or 2K refresh
Soldered DRAM	None
Number of DIMM Slots	2
Supported Sizes in MB	4, 8, 16, 32, 64
Maximum DRAM	128 MB
Virtual Memory	1 GB
Soldered VRAM	2 MB
Number of VRAM Slots	None

Note: The Power Macintosh 6400 has two DIMM slots. You do not have to fill both slots when upgrading memory, nor do you have to use DIMMs of the same size. However, if you wish to take advantage of the computer's interleaving capability, which provides maximum performance, you must install the DIMMs in matching pairs. DIMMs purchased from different manufacturers can be paired as long as they are the same size and speed.

Note: Supported memory configurations include 16, 20, 24, 32, 36, 40, 48, 64, and 128 MB.

Note: This computer requires 1K or 2K refresh rate EDO DIMMs.





Power Macintosh 7100 Series

The Power Macintosh has 8 MB of DRAM soldered onto the logic board. You can expand the amount of memory to a total of 136 MB by installing DRAM SIMMs.

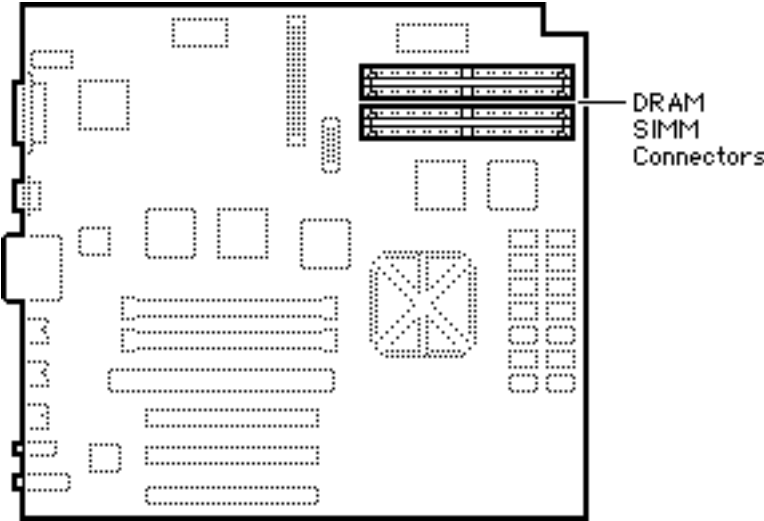

DRAM Configurations	
8 MB	The Power Macintosh 7100 Series logic boards have 8 MB of soldered DRAM.
Up to 136 MB	Use 4, 8, 16, or 32 MB 72-pin SIMMs.

Note: SIMMs must be installed in pairs of the same size or the system will read both SIMMs at the higher density. System crashes are possible in this situation.

Note: The Power Macintosh 7100 operates in 32-bit mode only and cannot be toggled back to 24-bit mode.

Memory Information	
DRAM Speed	80 ns
SIMM Type	72-pin
Soldered DRAM	8 MB
Number of SIMM Slots	4
Supported Sizes in MB	4, 8, 16, 32
Maximum DRAM	136 MB
Virtual Memory	1 GB
Soldered VRAM	1 MB (on card)
Number of VRAM Slots	See VRAM Note

VRAM Note: The non-AV versions of the PM 7100 computers must have the Power Macintosh 2 MB Video Card installed for video support. This video card has 1 MB of soldered VRAM and is expandable to 2 MB of VRAM using four 256K VRAM SIMMs. The AV versions of the PM 7100 use the AV card, which comes with 2 MB of VRAM and is not upgradeable.





Power Macintosh 7200 Series

The Power Macintosh 7200 Series logic boards have four DRAM DIMM slots, each with a 64-bit data bus. You can increase the computer's DRAM to a total of 256 MB using 5-volt, 64-bit-wide, 168-pin, fast-paged mode, 70ns DIMMs.

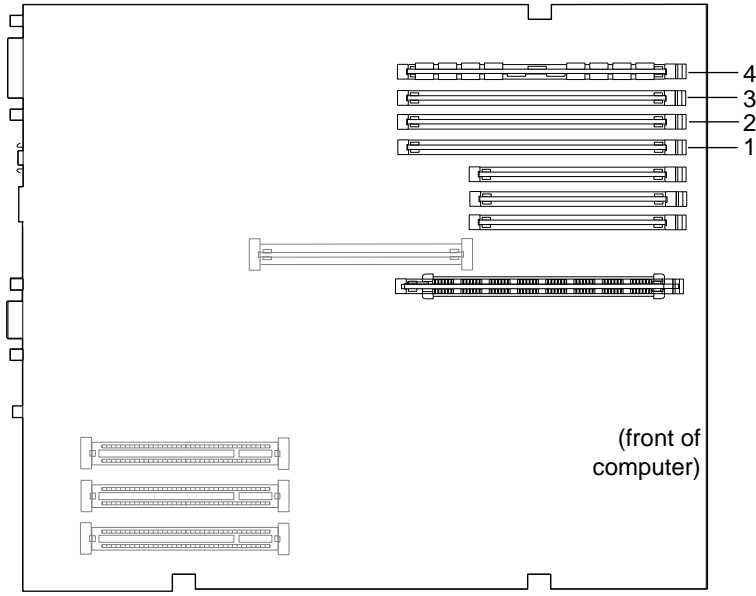

DRAM Configurations	
8 MB	The Power Macintosh 7200 Series logic boards have 8 MB of DRAM installed.
Up to 256 MB	Use 4, 8, 16, or 32 MB 168-pin DIMMs.

Memory Information	
DRAM Speed	70 ns
DIMM Type	168-pin
Soldered DRAM	None
Number of DIMM Slots	4
Supported Sizes in MB	4, 8, 16, 32
Maximum DRAM	256 MB
Virtual Memory	1 GB
Soldered VRAM	1 MB
Number of VRAM Slots	3

Note: DRAM DIMMs can be installed individually or in pairs. These computers support linear memory only; therefore, no memory gains are seen when two DIMMs of the same size are installed (that is, memory interleaving is not supported on the Power Macintosh 7200 Series computers).

Note: The Single In-Line Memory Modules (SIMMs) used in previous Macintosh models are **not** compatible with the Power Macintosh 7200.

Note: These computers do not have any main memory soldered to the logic board. At least one DRAM DIMM must be installed for the computer to operate.





Power Macintosh 7300 Series

The Power Macintosh 7300 Series computers have no DRAM soldered onto the logic board. You can expand the amount of memory to a total of 512 MB using 5-volt, 64-bit-wide, 168-pin fast-paged mode or EDO DIMMs.

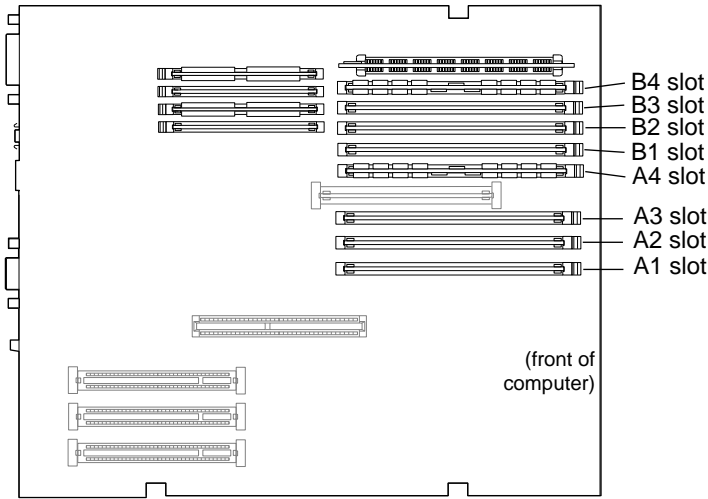

DRAM Configurations	
16 or 32 MB	The Power Macintosh 7300 Series logic boards have 16 or 32 MB of installed DRAM.
Up to 512 MB	Use 4, 8, 16, 32, or 64 MB 168-pin DIMMs.

Memory Information	
DRAM Speed	70 ns
DIMM Type	+5V 168-pin
Soldered DRAM	None
Number of DIMM Slots	8
Supported Sizes in MB	4, 8, 16, 32, 64
Maximum DRAM	512 MB
Virtual Memory	1 GB
Soldered VRAM	None
Number of VRAM Slots	4

Note: DRAM DIMMs can be installed individually; however, to provide maximum performance, install the DIMMs in matching pairs and in paired slots (A4 and B4 first, then A3 and B3, etc.).

Note: The Single In-Line Memory Modules (SIMMs) used in previous Macintosh models are NOT compatible with the Power Macintosh 7300. This computer supports +5V DIMMs only.

Note: These computers do not have any main memory soldered to the logic board. At least one DRAM DIMM must be installed for the computer to operate.





Power Macintosh 7500 Series

The Power Macintosh 7500 Series computers have no DRAM soldered onto the logic board. You can expand the amount of memory to a total of 512 MB using 5-volt, 64-bit-wide, 168-pin fast-paged mode or EDO DIMMs.

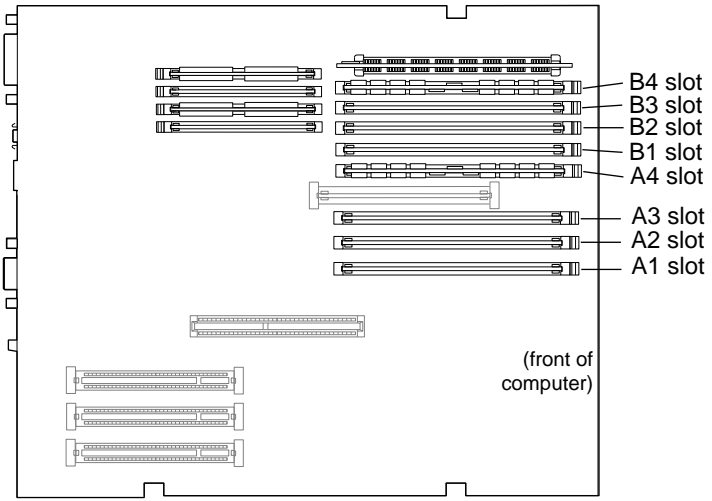

DRAM Configurations	
8 MB	The Power Macintosh 7500 Series logic boards have 8 MB of installed DRAM.
Up to 512 MB	Use 4, 8, 16, 32, or 64 MB 168-pin DIMMs.

Memory Information	
DRAM Speed	70 ns
DIMM Type	+5V 168-pin
Soldered DRAM	None
Number of DIMM Slots	8
Supported Sizes in MB	4, 8, 16, 32, 64
Maximum DRAM	512 MB
Virtual Memory	1 GB
Soldered VRAM	None
Number of VRAM Slots	4

Note: DRAM DIMMs can be installed individually; however, to provide maximum performance, install the DIMMs in matching pairs and in paired slots (A4 and B4 first, then A3 and B3, etc.).

Note: The Single In-Line Memory Modules (SIMMs) used in previous Macintosh models are NOT compatible with the Power Macintosh 7500. This computer supports +5V DIMMs only.

Note: These computers do not have any main memory soldered to the logic board. At least one DRAM DIMM must be installed for the computer to operate.





Power Macintosh 7600 Series

The Power Macintosh 7600 has no DRAM soldered onto the logic board. You can expand the amount of memory to a total of 512 MB using 5-volt, 64-bit-wide, 168-pin fast-paged mode or EDO DIMMs.

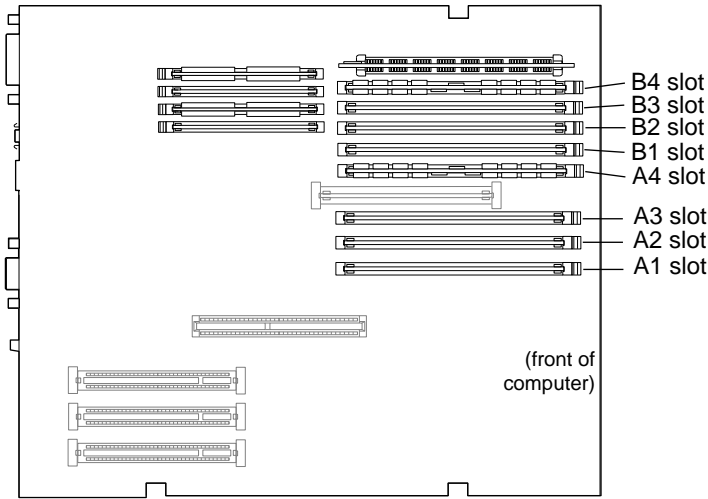

DRAM Configurations	
16 or 32 MB	The Power Macintosh 7600 logic board has 16 or 32 MB of installed DRAM.
Up to 512 MB	Use 4, 8, 16, 32, or 64 MB 168-pin DIMMs.

Memory Information	
DRAM Speed	70 ns
DIMM Type	+5V 168-pin
Soldered DRAM	None
Number of DIMM Slots	8
Supported Sizes in MB	4, 8, 16, 32, 64
Maximum DRAM	512 MB
Virtual Memory	1 GB
Soldered VRAM	None
Number of VRAM Slots	4

Note: DRAM DIMMs can be installed individually; however, to provide maximum performance, install the DIMMs in matching pairs and in paired slots (A4 and B4 first, then A3 and B3, etc.).

Note: The Single In-Line Memory Modules (SIMMs) used in previous Macintosh models are NOT compatible with the Power Macintosh 7600. This computer supports +5V DIMMs only.

Note: The Power Macintosh 7600 does not have any main memory soldered to the logic board. At least one DRAM DIMM must be installed for the computer to operate.





Power Macintosh 8100 Series

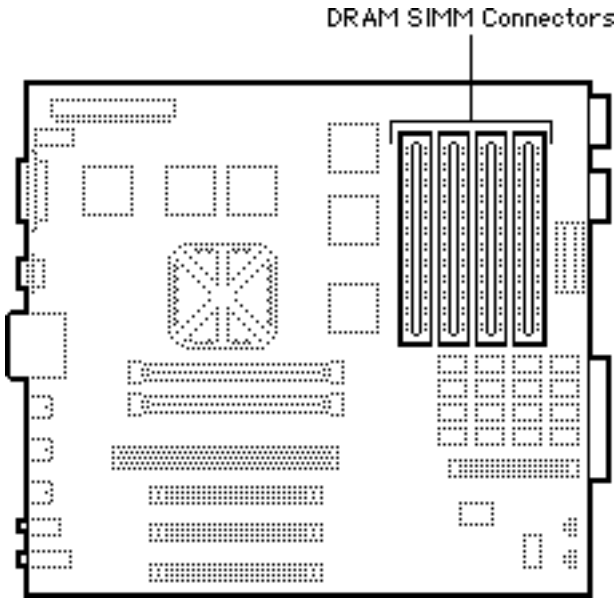

The Power Macintosh 8100 Series logic boards have 8 MB of soldered DRAM. You can expand the memory to a total of 264 MB by installing DRAM SIMMs.

The Power Macintosh 8100 operates in 32-bit mode only and cannot be toggled back to 24-bit mode.

DRAM Configurations	
8 MB	The Power Macintosh 8100 Series logic boards have 8 MB of soldered DRAM.
Up to 264 MB	Use 4, 8, 16, or 32 MB 72-pin SIMMs.

Note: SIMMs must be installed in pairs, and both SIMMs in the pair must be of the same size; Failure to do so will result in the Power Mac thinking both SIMMs are of the (wrong) density. System crashes are possible in this situation.

You can install different size SIMMs just as long as you install them in matched pairs; for example, you could install a pair of 8 MB SIMMs and a pair of 32 MB SIMMs.

Memory Information	
DRAM Speed	80 ns
SIMM Type	72-pin
Soldered DRAM	8 MB
Number of SIMM Slots	8
Supported Sizes in MB	4, 8, 16, 32
Maximum DRAM	264 MB
Virtual Memory	1 GB
Soldered VRAM	2 MB (on card)
Number of VRAM Slots	See VRAM Note

VRAM Note: VRAM may be expanded to 4 MB on a Power Macintosh 8100 Series logic board by inserting four 68-pin, 80 ns SIMMs in connectors on the video card.





Power Macintosh 8500 Series

The Power Macintosh 8500 Series logic boards have eight DRAM DIMM slots, each with a 64-bit data bus. You can increase the computer's DRAM to a total of 512 MB using 5-volt, 64-bit-wide, 168-pin fast-paged mode, 70ns DIMMs.

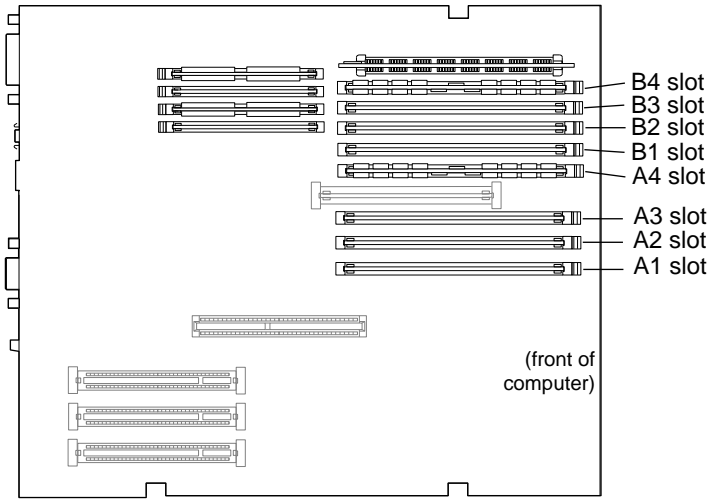

DRAM Configurations	
8 MB	The Power Macintosh 8500 logic boards have 8 MB of DRAM installed.
Up to 512 MB	Use 4, 8, 16, 32 or 64 MB 168-pin DIMMs.

Note: DRAM DIMMs can be installed individually; however, to provide maximum performance, install the DIMMs in matching pairs and in paired slots (A4 and B4 first, then A3 and B3, etc.).

Note: The Single In-Line Memory Modules (SIMMs) used in previous Macintosh models are **not** compatible with the Power Macintosh 8500.

Note: These computers do not have any main memory soldered to the logic board. At least one DRAM DIMM must be installed for the computer to operate.

Memory Information	
DRAM Speed	70 ns
DIMM Type	168-pin
Soldered DRAM	None
Number of DIMM Slots	8
Supported Sizes in MB	4, 8, 16, 32, 64
Maximum DRAM	512 MB
Virtual Memory	1 GB
Soldered VRAM	See VRAM Notes
Number of VRAM Slots	4

VRAM Note: This computer also uses VRAM DIMMs (112-pin 70ns or faster) instead of VRAM SIMMs. The VRAM SIMMs used in earlier Power Macintosh models are not compatible.





Power Macintosh 8600 Series

The Power Macintosh 8600 Series logic boards have eight DRAM DIMM slots, each with a 64-bit data bus. You can increase the computer's DRAM to a total of 512 MB using 5-volt, 64-bit-wide, 168-pin fast-paged mode or EDO DIMMs.

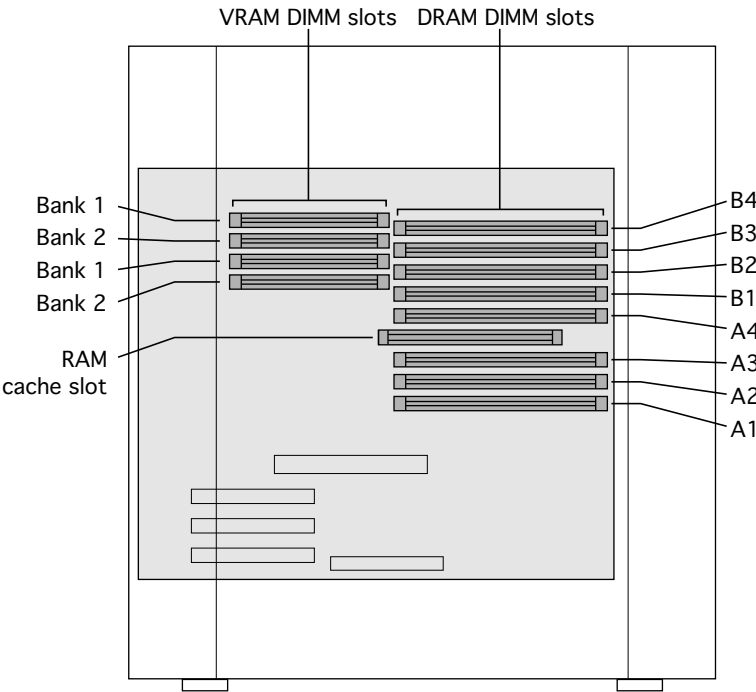

DRAM Configurations	
32 MB	The Power Macintosh 8600 logic board has 32 MB of installed DRAM.
Up to 512 MB	Use 4, 8, 16, 32, or 64 MB 168-pin DIMMs.

Note: DRAM DIMMs can be installed individually; however, to provide maximum performance, install the DIMMs in matching pairs and in paired slots (A4 and B4 first, then A3 and B3, etc.).

Note: The Single In-Line Memory Modules (SIMMs) used in previous Macintosh models are NOT compatible with the Power Macintosh 8600. This computer supports +5V DIMMs only.

Note: The Power Macintosh 8600 does not have any main memory soldered to the logic board. At least one DRAM DIMM must be installed for the computer to operate.

Memory Information	
DRAM Speed	70 ns
DIMM Type	+5V 168-pin
Soldered DRAM	None
Number of DIMM Slots	8
Supported Sizes in MB	4, 8, 16, 32, 64
Maximum DRAM	512 MB
Virtual Memory	1 GB
Soldered VRAM	None (See Note)
Number of VRAM Slots	4 (2 MB installed)

VRAM Note: This computer uses VRAM DIMMs (112-pin, 70 ns or faster) instead of VRAM SIMMs. The VRAM SIMMs used in earlier Power Macintosh models are not compatible. There are 4 VRAM slots. 1 MB DIMMs are installed in pairs, making VRAM expandable to 4MB.





Power Macintosh 9500 Series

The Power Macintosh 9500 Series logic boards do not have any soldered DRAM. At least one DRAM DIMM must be installed for the computer to operate.

You can expand the memory to a theoretical limit of 1536 MB; however, Apple has tested only up to a limit of 768 MB.

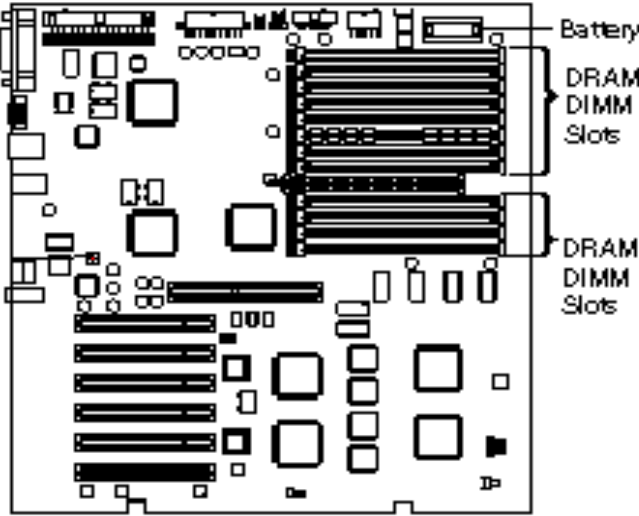

DRAM Configurations	
8 MB	The Power Macintosh 9500 logic boards have 8 MB of DRAM DIMMs installed.
Up to 1.5 GB	Use 4, 8, 16, 32, or 64 MB 168-pin DIMMs.

Note: DRAM DIMMs can be installed individually; however, to provide maximum performance, install the DIMMs in matching pairs and in paired slots (A6 and B6 first, then A5 and B5, etc.).

Note: The Single In-Line Memory Modules (SIMMs) used in previous Macintosh models are **not** compatible with the Power Macintosh 9500.

VRAM Note: No VRAM upgrade is available from Apple. Since PM 9500 computers without video cards require third-party PCI video support, the VRAM requirements and capabilities vary by manufacturer.

See additional notes on the following page.

Memory Information	
DRAM Speed	70 ns
DIMM Type	168-pin
Soldered DRAM	None
Number of DIMM Slots	12
Supported Sizes in MB	4, 8, 16, 32, 64, 128
Maximum DRAM	768 MB tested and 1536 MB theoretical limit
Virtual Memory	1 GB
Soldered VRAM	See VRAM Note
Number of VRAM Slots	See VRAM Note
Cache DIMM Slot	No





DIMMs

Whereas SIMMs have 72-pins, DIMMs have 168 pins. The extra pins provide a 64-bit data path, compared to a 32-bit data path for SIMMs. In addition, DIMMs do not have to be installed in pairs like the SIMMs on earlier Macintosh models. (However, to take advantage of memory interleaving, the DIMMs should be installed in paired slots. See “DIMMs” in Miscellaneous for more information.)

Memory Configurations

The Power Macintosh 9500 Series logic boards have 12 DRAM DIMM slots, each with a 64-bit data bus. You can increase the computer's DRAM to a theoretical total of 1536 MB using 5-volt, 64-bit-wide, 168-pin fast-paged mode, 70 ns DIMMs.

When installing DRAM DIMMs in the Power Macintosh 9500, fill slot A6 first, followed by B6, then A5, followed by B5, and so on. DRAM DIMMs can be installed individually; however, to take advantage of memory interleaving (see Note below), which provides maximum performance, you must install the DIMMs in matching pairs and in paired slots (A6 and B6 first, then A5 and B5, and so on).

DIMMs purchased from different manufacturers can be paired as long as they are the same size and speed.

Note: Memory interleaving allows the computer to read or write to its memory while other memory reads or writes are occurring, thus providing for faster performance.





Power Macintosh 9600 Series

The Power Macintosh 9600 Series logic boards do not have any soldered DRAM. At least one DRAM DIMM must be installed for the computer to operate.

You can expand the memory to a total of 768 MB using 5-volt, 64-bit-wide, 168-pin fast-paged mode or EDO DIMMs.

DRAM DIMM slots

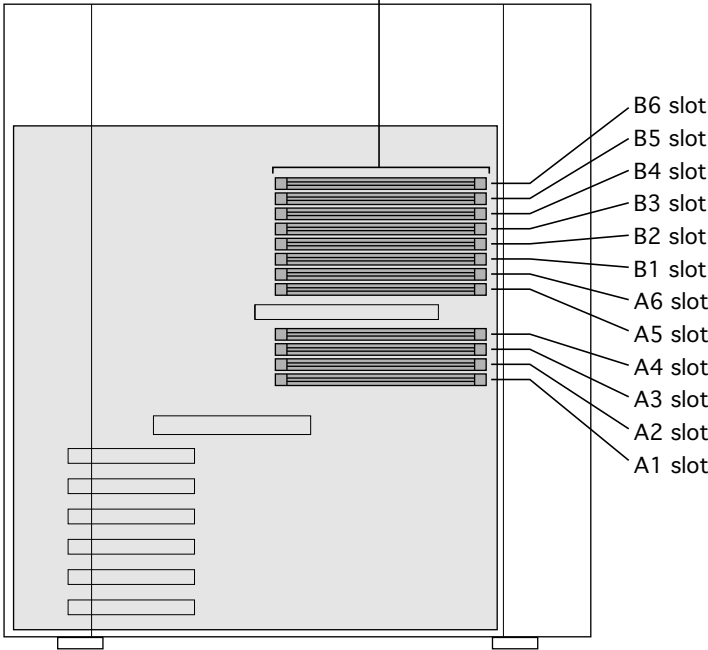

DRAM Configurations	
32 MB	The Power Macintosh 9600 logic boards have 32 MB of installed DRAM.
64 MB	The Power Macintosh 9600/300 and 9600/350 logic boards have 64 MB of installed DRAM.
Up to 768 MB	Use 4, 8, 16, 32, or 64 MB 168-pin DIMMs.

Note: DRAM DIMMs can be installed individually; however, to provide maximum performance, install the DIMMs in matching pairs and in paired slots (A4 and B4 first, then A3 and B3, etc.).

Note: The Single In-Line Memory Modules (SIMMs) used in previous Macintosh models are NOT compatible with the Power Macintosh 9600. This computer supports +5V DIMMs only.

Memory Information	
DRAM Speed	70 ns
DIMM Type	168-pin
Soldered DRAM	None
Number of DIMM Slots	12
Supported Sizes in MB	4, 8, 16, 32, 64
Maximum DRAM	768 MB
Virtual Memory	1 GB
Soldered VRAM	See VRAM Note
Number of VRAM Slots	See VRAM Note
Cache DIMM Slot	No

VRAM Note: The Power Macintosh 9600 Series computers come standard with 4 MB of VRAM on the video card (9600/300 and 9600/350 have 8 MB VRAM). There is no VRAM soldered on the logic board and no VRAM slots are on the logic board.

See additional notes on the following page





DIMMs

Whereas SIMMs have 72-pins, DIMMs have 168 pins. The extra pins provide a 64-bit data path, compared to a 32-bit data path for SIMMs. In addition, DIMMs do not have to be installed in pairs like the SIMMs on earlier Macintosh models. (However, to take advantage of memory interleaving, the DIMMs should be installed in paired slots. See “DIMMs” in Miscellaneous for more information.)

Memory Configurations

The Power Macintosh 9600 Series logic boards have 12 DRAM DIMM slots, each with a 64-bit data bus. You can increase the computer’s DRAM to 768 MB using 5-volt, 64-bit-wide, 168-pin fast-paged mode or EDO DIMMs.

When installing DRAM DIMMs in the Power Macintosh 9600, fill slot A6 first, followed by B6, then A5, followed by B5, and so on. DRAM DIMMs can be installed individually; however, to take advantage of memory interleaving (see Note below), which provides maximum performance, you must install the DIMMs in matching pairs and in paired slots (A6 and B6 first, then A5 and B5, and so on).





Twentieth Anniversary Macintosh

The Twentieth Anniversary Macintosh logic boards do not have any soldered DRAM. At least one DRAM DIMM must be installed for the computer to operate.

You can expand the memory to a total of 128 MB using 5-volt, 64-bit-wide, 168-pin fast-paged mode or EDO DIMMs.

Twentieth Anniversary Logic Board

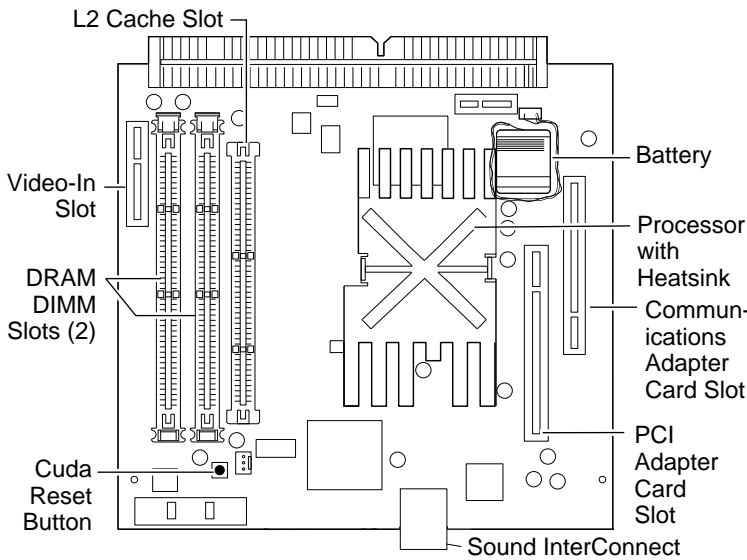

DRAM Configurations	
32 MB	The Twentieth Anniversary Macintosh logic boards have 32 MB of installed DRAM (one 32 MB DIMM).
Up to 128 MB	Use 4, 8, 16, 32, or 64 MB 168-pin DIMMs.

Memory Information	
DRAM Speed	60 ns
DIMM Type	168-pin
Soldered DRAM	None
Number of DIMM Slots	2
Supported Sizes in MB	4, 8, 16, 32, 64
Maximum DRAM	128 MB
Virtual Memory	1 GB
Soldered VRAM	2 MB SGRAM
Number of VRAM Slots	1 already filled
Cache DIMM Slot	1 already filled with 256K

Note: The Single In-Line Memory Modules (SIMMs) used in previous Macintosh models are NOT compatible with the Twentieth Anniversary Macintosh. This computer supports +5V DIMMs only.

Note: Supported memory configurations include 16, 20, 24, 32, 36, 40, 48, 64, 80, 96, and 128 MB.

Note: This computer requires 64-bit wide, 5-volt, 2K refresh rate EDO or fast-page mode DIMMs. This computer cannot use 3.3-volt and 4K refresh rate DIMMs.





Power Macintosh G3 Desktop

The Power Macintosh G3 Desktop computer uses a new type of memory called SDRAM.

This computer comes standard with 32 MB of SDRAM (one 32 MB DRAM DIMM). You can expand the total memory to a maximum of 192 MB* using 64-bit, JEDEC standard, 3.3 V, unbuffered SDRAM DIMMs.

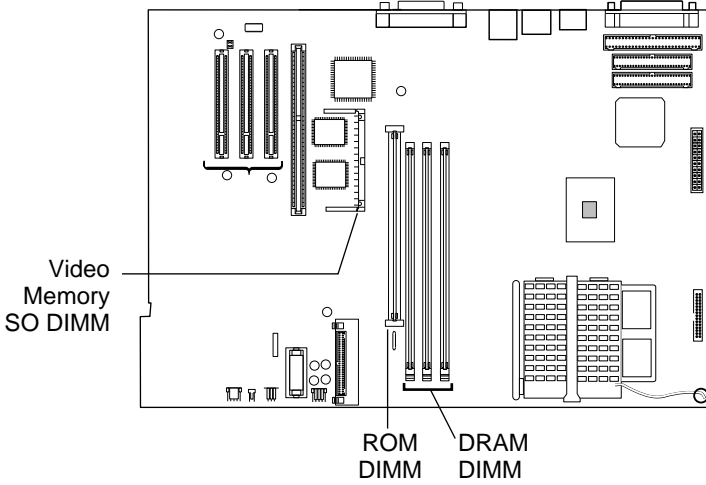

SDRAM Configurations	
32 MB	The Power Macintosh G3 Desktop logic boards come standard with 32 MB of SDRAM (one 32 MB DIMM).
Up to 192 MB	Use 4, 8, 16, 32, or 64 MB 168-pin DIMMs.

Note: SDRAM DIMMs can be installed one at a time and in any slot as there are no interleaving benefits.

*The logic board supports a maximum of 384 MB of DRAM, but 128 MB JEDEC industry-standard DIMMs are too tall to fit in the chassis, which limits the DRAM to 192 MB.

Memory Information	
SDRAM Speed	10 ns
DIMM Type	168-pin
Soldered SDRAM	None
Number of DIMM Slots	3
Supported Sizes in MB	4, 8, 16, 32, 64
Maximum SDRAM	192 MB
Virtual Memory	1 GB
Soldered Video Memory	2 MB SGRAM
Number of Video Memory Slots	1
Cache DIMM Slot	No

Video Memory Note: The computer comes standard with 2 MB of SGRAM video memory. There is one video memory slot on the board that accepts up to a 4 MB SGRAM module for a maximum of 6 MB of video memory.





Power Macintosh G3 Minitower

The Power Macintosh G3 Minitower computer uses a new type of memory called SDRAM.

This computer comes standard with 32 MB of SDRAM (one 32 MB DRAM DIMM). You can expand the total memory to a maximum of 384 MB using 64-bit, JEDEC standard, 3.3 V, unbuffered SDRAM DIMMs.

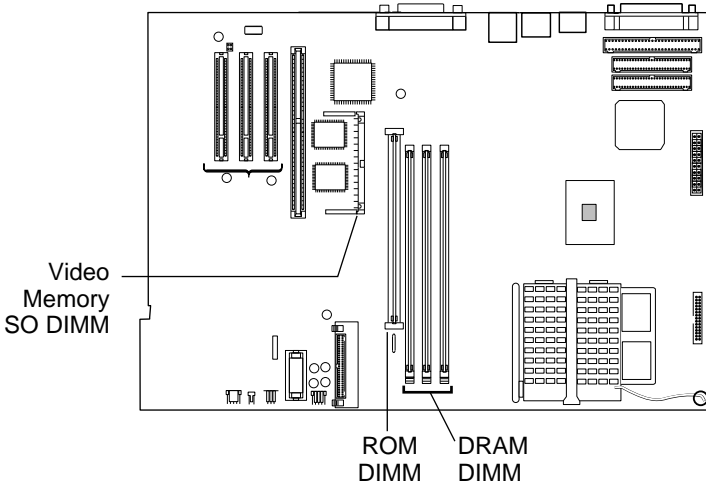

DRAM Configurations	
32 MB	The Power Macintosh G3 Minitower logic boards come standard with 32 MB of SDRAM (one 32 MB DIMM).
Up to 384 MB	Use 4, 8, 16, 32, 64, or 128 MB 168-pin DIMMs.

Note: SDRAM DIMMs can be installed one at a time and in any slot as there are no interleaving benefits.

Memory Information	
SDRAM Speed	10 ns
DIMM Type	168-pin
Soldered SDRAM	None
Number of DIMM Slots	3
Supported Sizes in MB	4, 8, 16, 32, 64, 128
Maximum SDRAM	384 MB
Virtual Memory	1 GB
Soldered Video Memory	2 MB SGRAM
Number of Video Memory Slots	1
Cache DIMM Slot	No

Video Memory Note: The computer comes standard with 2 MB of SGRAM video memory. There is one video memory slot on the board that accepts up to a 4 MB SGRAM module for a maximum of 6 MB of video memory.





Power Macintosh G3 All-In-One

Designed for the K-12 market, the G3 All-In-One fulfills the needs of teachers and students.

The Power Macintosh G3 All-In-One computer uses a type of memory called SDRAM.

This computer comes standard with 32 MB of SDRAM (one 32 MB DRAM DIMM). You can expand the total memory to a maximum of 384 MB.

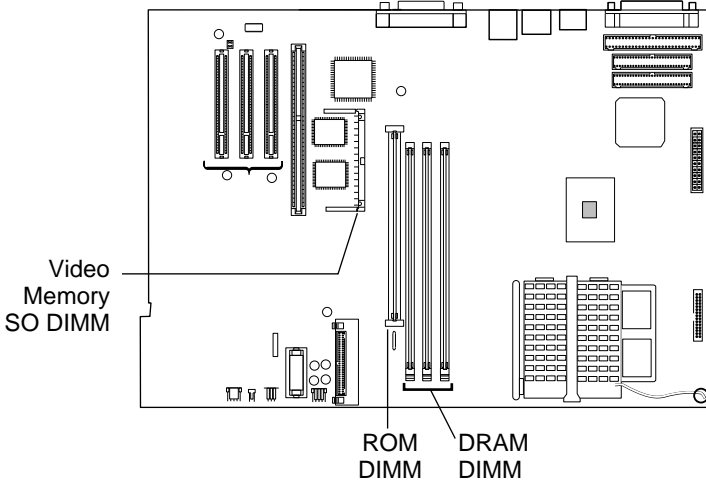

DRAM Configurations	
32 MB	The Power Macintosh G3 All-In-One logic boards come standard with 32 MB of SDRAM (one 32 MB DIMM).
Up to 384 MB	Use 4, 8, 16, 32, 64, or 128 MB 168-pin DIMMs.

Note: SDRAM DIMMs can be installed one at a time and in any slot as there are no interleaving benefits.

Memory Information	
SDRAM Speed	10 ns
DIMM Type	168-pin
Soldered SDRAM	None
Number of DIMM Slots	3
Supported Sizes in MB	4, 8, 16, 32, 64, 128
Maximum SDRAM	384 MB
Virtual Memory	1 GB
Soldered Video Memory	2 MB SGRAM
Number of Video Memory Slots	1
Cache DIMM Slot	No

Video Memory Note: The computer comes standard with 2 MB of SGRAM video memory. There is one video memory slot on the board that accepts up to a 4 MB SGRAM module for a maximum of 6 MB of video memory.





WorkGroup Servers



AWS 60

The Apple WorkGroup Server 60 has 8 MB of DRAM soldered to the logic board.

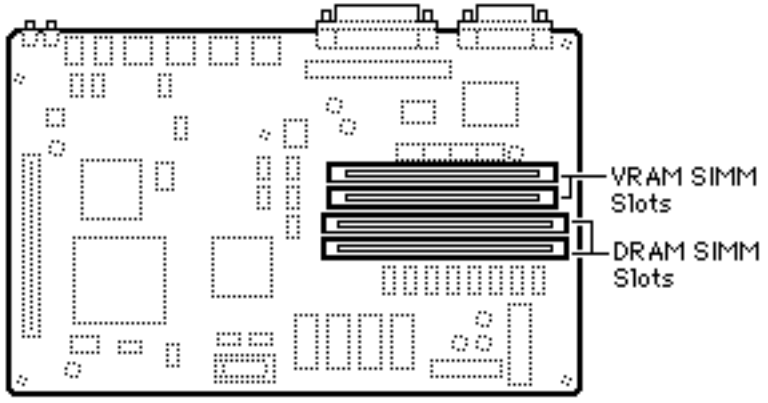

DRAM Configurations	
8 MB	The AWS 60 logic board has 8 MB of soldered DRAM.
Up to 72 MB	Use 4, 8, 16, or 32 MB 72-pin SIMMs.

Memory Information	
DRAM Speed	80 ns
SIMM Type	72-pin
Soldered DRAM	8 MB
Number of SIMM Slots	2
Supported Sizes in MB	4, 8, 16, 32
Maximum DRAM	72 MB
Virtual Memory	1 GB
Soldered VRAM	512K
Number of VRAM Slots	2

The AWS 60 uses “memory interleaving” which occurs when like SIMM pairs are used (for example: two 8MB SIMMs). Basically, it allows the memory subsystem to write to the same memory address in different banks of memory before incrementing the address. Depending on how memory intensive the application is, memory interleaving can improve performance 5% to 10%.

Note: You can mix SIMM sizes

Note: Use 80 ns or faster VRAM SIMMs.





AWS 80

The AWS 80 has 8 MB of DRAM soldered to the logic board. Total memory can be expanded to 136 MB.

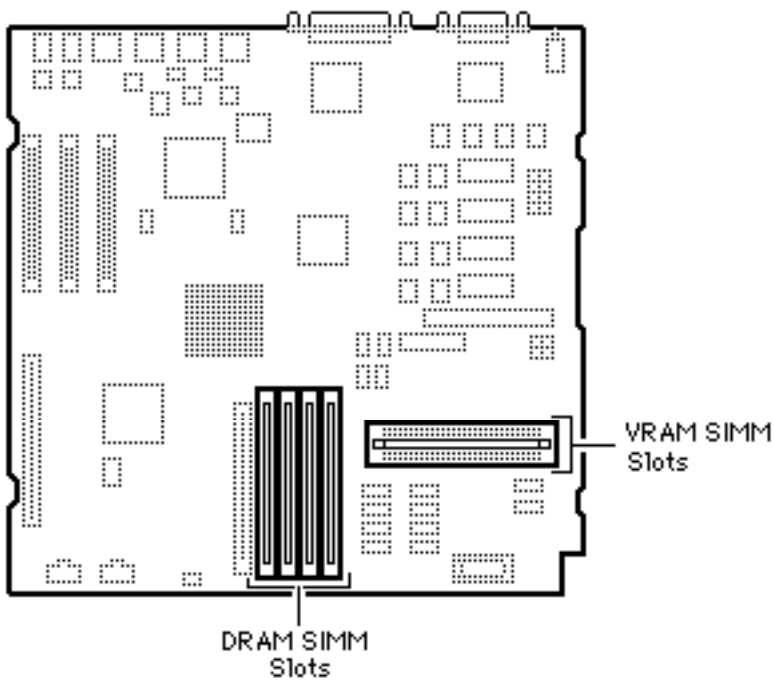

DRAM Configurations	
8 MB	The Apple Workgroup Server 80 logic board has 8 MB of soldered DRAM.
136 MB	Use 1, 4, 8, 16, or 32 MB 72-pin SIMMs.

Memory Information	
DRAM Speed	60 ns
SIMM Type	72-pin
Soldered DRAM	8 MB
Number of SIMM Slots	4
Supported Sizes in MB	1, 4, 8, 16, 32
Maximum DRAM	136 MB
Virtual Memory	1 GB
Soldered VRAM	512K
Number of VRAM Slots	2

The AWS 80 uses “memory interleaving” which occurs when like SIMM pairs are used (for example two 8 MB SIMMs). Basically, it allows the memory subsystem to write to the same memory address in different banks of memory before incrementing the address. Depending on how memory-intensive the application is, memory interleaving can improve performance 5% to 10%.

Note: Use 80 ns or faster VRAM SIMMs.





AWS 95

The Apple WorkGroup Server 95 has no soldered DRAM. Total memory can be expanded to 256 MB.

IMPORTANT: Do **not** use composite SIMMs in the AWS 95.

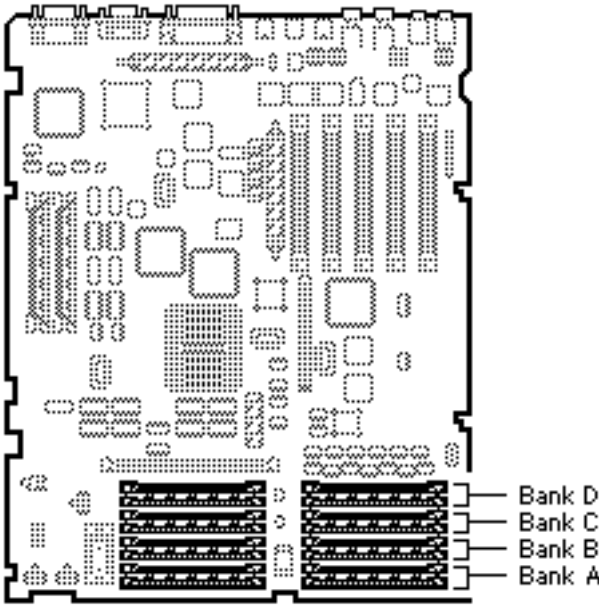

DRAM Configurations	
16 MB	The AWS 95 logic board has no soldered DRAM. A total of 16 MB of memory (two 8 MB SIMMs) is standard.
Up to 256 MB	Use 1, 4, or 16 MB 30-pin SIMMs.

Note: AWS 95 systems are shipped from Apple with 9-bit parity DRAM installed. Standard non-parity DRAM can be installed however, parity checking is disabled when non-parity DRAM is present.

Memory Information	
DRAM Speed	80 ns
SIMM Type	30-pin
Soldered DRAM	none
Number of SIMM Slots	16
Supported Sizes in MB	1, 4, 8, 16 (see Note)
Maximum DRAM	256 MB
Virtual Memory	1 GB
Soldered VRAM	1 MB
Number of VRAM Slots	4

Note: Fill a bank with DRAM SIMMs of the same size or leave the bank empty (no partially filled banks).

VRAM Configurations	
2 MB	Install two 256K or 512K VRAM SIMMs.

Note: Use 80 ns or faster VRAM SIMMs. The AWS 95 uses only 256K of each 512K VRAM SIMM installed.





WorkGroup Server 6150

The WorkGroup Server 6150 has 8 MB of DRAM soldered onto the logic board. You can expand the amount of memory to a total of 72 MB by installing DRAM SIMMs.

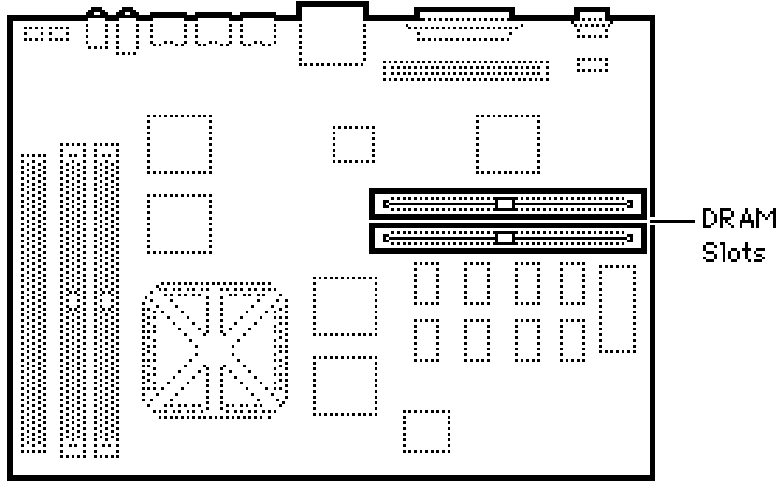

DRAM Configurations	
8 MB	The WS 6150 logic board has 8 MB of soldered DRAM.
Up to 72 MB	Use 4, 8, 16, or 32 MB 72-pin SIMMs.

Memory Information	
DRAM Speed	80 ns
SIMM Type	72-pin
Soldered DRAM	8 MB
Number of SIMM Slots	2
Supported Sizes in MB	4, 8, 16, 32
Maximum DRAM	72 MB
Virtual Memory	1 GB
Soldered VRAM	None
Number of VRAM Slots	None
Cache SIMM slot	Yes
Cache SIMM size	256K

Note: SIMMs must be installed in matching pairs. Failure to do so will result in the system thinking that both SIMMs are of the higher density. System crashes are possible in this situation.

Note: Install noncomposite SIMMs only.





WorkGroup Server 7250

The WorkGroup Server 7250 logic board has four DRAM DIMM slots, each with a 64-bit data bus. You can increase the computer's DRAM to a total of 256 MB using 5-volt, 64-bit-wide, 168-pin, fast-paged mode, 70ns DIMMs.

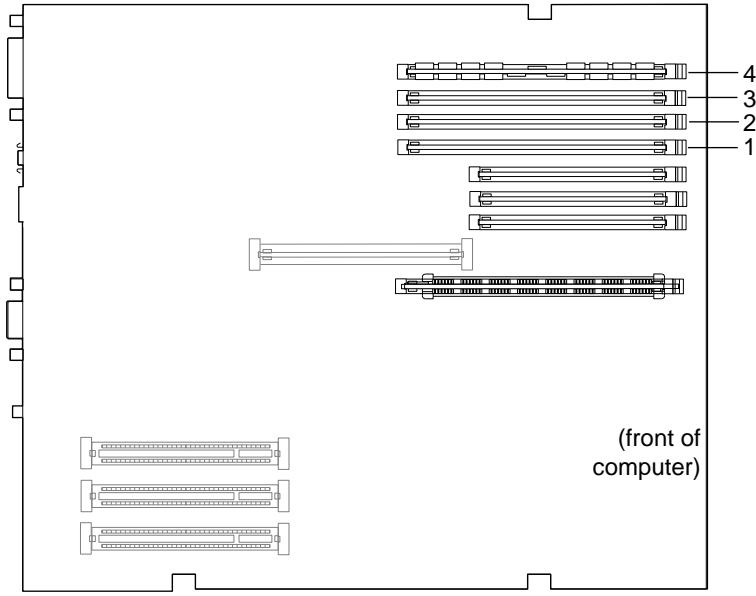

DRAM Configurations	
16 MB	The WS 7250 logic board has 16 MB of DRAM installed.
Up to 256 MB	Use 4, 8, 16, or 32 MB 168-pin DIMMs.

Memory Information	
DRAM Speed	70 ns
DIMM Type	168-pin
Soldered DRAM	None
Number of DIMM Slots	4
Supported Sizes in MB	4, 8, 16, 32
Maximum DRAM	256 MB
Virtual Memory	1 GB
Soldered VRAM	1 MB
Number of VRAM Slots	3

Note: DRAM DIMMs can be installed individually or in pairs. These computers support linear memory only; therefore, no memory gains are seen when two DIMMs of the same size are installed (that is, memory interleaving is not supported on the WS 7250 computers). The DRAM slots are numbered, but DRAM can be installed in any order.

Note: The Single In-Line Memory Modules (SIMMs) used in previous Macintosh models are **not** compatible with the WS 7250.

Note: These computers do not have any main memory soldered to the logic board. At least one DRAM DIMM must be installed for the computer to operate.





Workgroup Server 8150

The Workgroup Server 8150 has 8 or 16 MB of DRAM soldered onto the logic board. You can expand the amount of memory to a total of 264 MB by installing DRAM SIMMs.

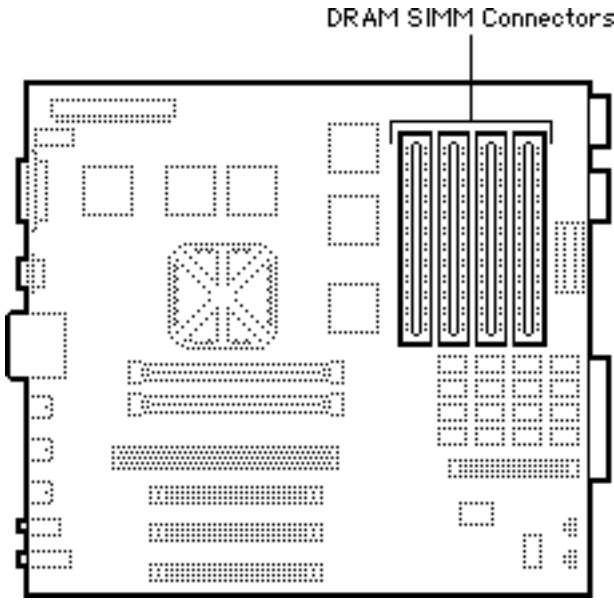

DRAM Configurations	
8/16 MB	The WS 8150 logic board has 8 or 16 MB of soldered DRAM.
Up to 264 MB	Use 4, 8, 16, or 32 MB 72-pin SIMMs.

Note: SIMMs must be installed in pairs, and both SIMMs in the pair must be of the same size; Failure to do so will result in the Power Mac thinking both SIMMs are of the (wrong) density. System crashes are possible in this situation.

You can install different size SIMMs just as long as you install them in matched pairs; for example, you could install a pair of 8 MB SIMMs and a pair of 32 MB SIMMs.

Memory Information	
DRAM Speed	80 ns
SIMM Type	72-pin
Soldered DRAM	8/16 MB
Number of SIMM Slots	8
Supported Sizes in MB	4, 8, 16, 32
Maximum DRAM	264 MB
Virtual Memory	1 GB
Soldered VRAM	None
Number of VRAM Slots	See VRAM Note

VRAM Note: VRAM can be expanded to 4 MB by inserting four 68-pin, 80 ns SIMMs in connectors on the VRAM Expansion card.





WorkGroup Server 8550

The WorkGroup Server 8550 logic board has eight DRAM DIMM slots, each with a 64-bit data bus. You can increase the computer's DRAM to a total of 512 MB using 5-volt, 64-bit-wide, 168-pin fast-paged mode, 70ns DIMMs.

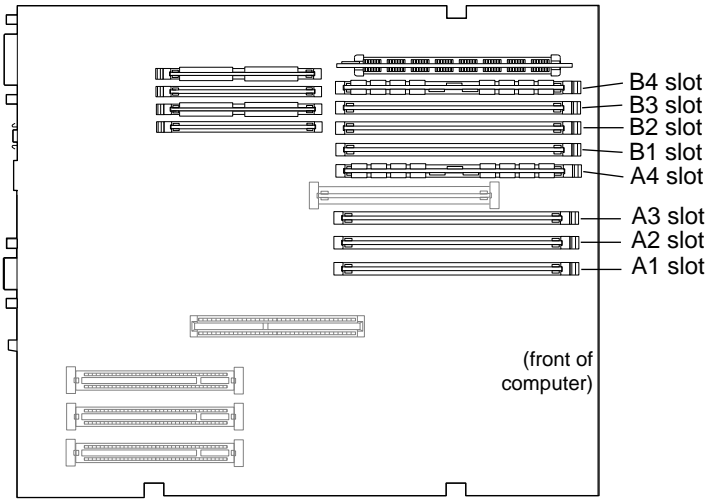

DRAM Configurations	
24 MB	The Power Macintosh 8500 logic boards have 24 MB of DRAM installed.
Up to 512 MB	Use 4, 8, 16, 32 or 64 MB 168-pin DIMMs.

Memory Information	
DRAM Speed	70 ns
DIMM Type	168-pin
Soldered DRAM	None
Number of DIMM Slots	8
Supported Sizes in MB	4, 8, 16, 32, 64
Maximum DRAM	512 MB
Virtual Memory	1 GB
Soldered VRAM	See VRAM Notes
Number of VRAM Slots	4

Note: DRAM DIMMs can be installed individually; however, to provide maximum performance, install the DIMMs in matching pairs and in paired slots (A6 and B6 first, then A5 and B5, etc.).

Note: The Single In-Line Memory Modules (SIMMs) used in previous Macintosh models are **not** compatible with the WS 8550.

Note: The WS 8550 does not have any main memory soldered to the logic board. At least one DRAM DIMM must be installed for the computer to operate.

VRAM Note: This computer uses VRAM DIMMs (112-pin 70ns or faster) instead of VRAM SIMMs. The VRAM SIMMs used in earlier Power Macintosh models are not compatible.





Workgroup Server 9150

The Workgroup Server 9150 has 8 MB of DRAM soldered onto the logic board. You can expand the amount of memory to a total of 264 MB by installing DRAM SIMMs.

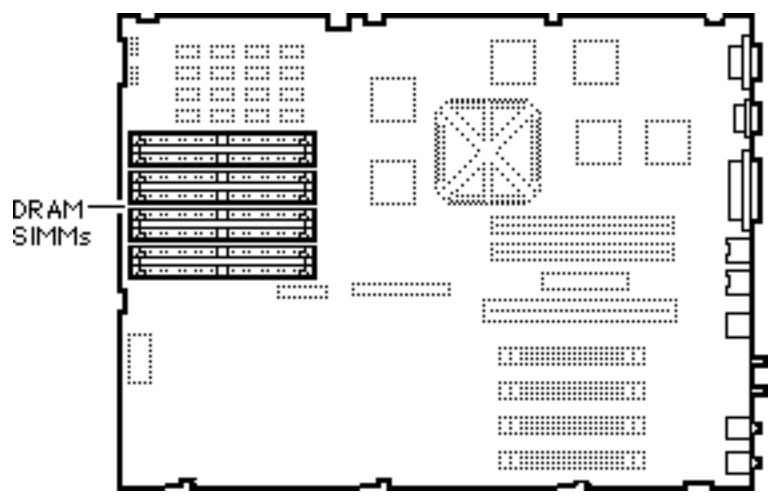

DRAM Configurations	
8 MB	The WS 9150 logic board has 8 MB of soldered DRAM.
Up to 264 MB	Use pairs of 4, 8, 16, or 32 MB 72-pin SIMMs.

Memory Information	
DRAM Speed	80 ns
SIMM Type	72-pin
Soldered DRAM	8 MB
Number of SIMM Slots	8
Supported Sizes in MB	4, 8, 16, 32
Maximum DRAM	264 MB
Virtual Memory	1 GB
Soldered VRAM	See VRAM Note
Number of VRAM Slots	None

Note: SIMMs must be installed in pairs.

Note: You can mix SIMM sizes.

Note: The WS 9150 operates in 32-bit mode at all times and cannot be toggled back to 24-bit mode.

VRAM Note: 1 MB of DRAM video support is provided on the logic board.





Network Server 500/700

The Network Server 500 and 700 logic boards have eight DRAM DIMM slots. You can increase the computer's DRAM to a total of 512 MB using 5-volt, parity, 64-bit-wide, 168-pin fast-paged mode, 60 ns DIMMs.

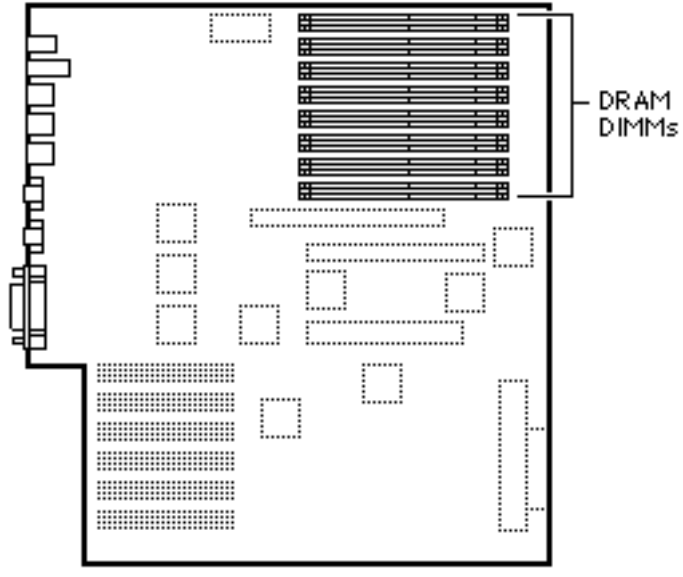

DRAM Configurations	
32 MB	Network Server 500
48 MB	Network Server 700
Up to 512 MB	Use pairs of 4, 8, 16, 32, or 64 MB 168-pin DIMMs.

Memory Information	
RAM Speed	60 ns
DIMM Type	168-pin
On-Board RAM	None
Number of SIMM Slots	8
Supported Sizes in MB	4, 8, 16, 32, 64
Maximum RAM	512 MB
Virtual Memory	1 GB
On-Board VRAM	None
Number of VRAM Slots	None

Note: DRAM DIMMs can be installed individually; however, to provide maximum performance, install the DIMMs in matching pairs and in paired slots (1A and 1B first, then 2A and 2B, etc.).

Note: The Single In-Line Memory Modules (SIMMs) used in previous Macintosh models are NOT compatible with the Network Servers.

Note: These computers do not have any main memory soldered to the logic board. At least one DRAM DIMM must be installed for the computer to operate.





Workgroup Server 7350

The Workgroup Server 7350 computer has no DRAM soldered onto the logic board. You can expand the amount of memory to a total of 512 MB using 5-volt, 64-bit-wide, 168-pin fast-paged mode or EDO DIMMs.

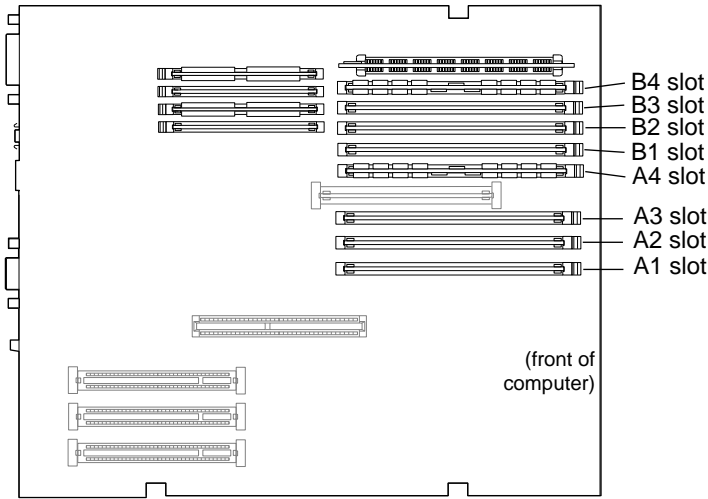

DRAM Configurations	
48 MB	The Workgroup Server 7350 logic boards have 48 MB of installed DRAM.
Up to 512 MB	Use 4, 8, 16, 32, or 64 MB 168-pin DIMMs.

Memory Information	
DRAM Speed	70 ns
DIMM Type	+5V 168-pin
Soldered DRAM	None
Number of DIMM Slots	8
Supported Sizes in MB	4, 8, 16, 32, 64
Maximum DRAM	512 MB
Virtual Memory	1 GB
Soldered VRAM	None
Number of VRAM Slots	4

Note: DRAM DIMMs can be installed individually; however, to provide maximum performance, install the DIMMs in matching pairs and in paired slots (A4 and B4 first, then A3 and B3, etc.).

Note: The Single In-Line Memory Modules (SIMMs) used in previous Macintosh models are NOT compatible with the Workgroup Server 7350. This computer supports +5V DIMMs only.

Note: These computers do not have any main memory soldered to the logic board. At least one DRAM DIMM must be installed for the computer to operate.





Workgroup Server 9650

The Workgroup Server 9650 logic boards do not have any soldered DRAM. At least one DRAM DIMM must be installed for the computer to operate.

You can expand the memory to a total of 768 MB using 5-volt, 64-bit-wide, 168-pin fast-paged mode or EDO DIMMs.

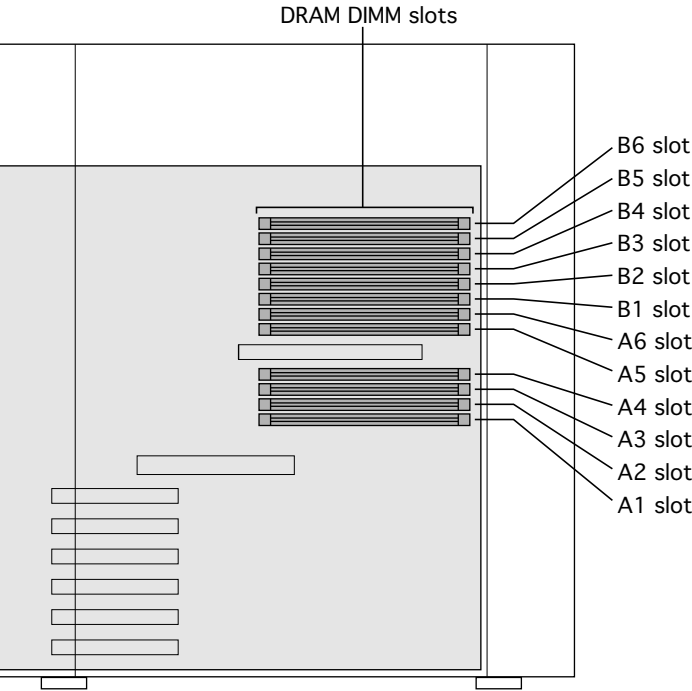

DRAM Configurations	
64 MB	The Workgroup Server 9650 logic boards have 64 MB of installed DRAM.
Up to 768 MB	Use 4, 8, 16, 32, or 64 MB 168-pin DIMMs.

Note: DRAM DIMMs can be installed individually; however, to provide maximum performance, install the DIMMs in matching pairs and in paired slots (A4 and B4 first, then A3 and B3, etc.).

Note: The Single In-Line Memory Modules (SIMMs) used in previous Macintosh models are NOT compatible with the Workgroup Server 9650. This computer supports +5V DIMMs only.

VRAM Note: The Workgroup Server 9650 comes standard with 4 MB of VRAM on the video card. There is no VRAM soldered on the logic board and no VRAM slots are on the logic board.

Memory Information	
DRAM Speed	70 ns
DIMM Type	168-pin
Soldered DRAM	None
Number of DIMM Slots	12
Supported Sizes in MB	4, 8, 16, 32, 64
Maximum DRAM	768 MB
Virtual Memory	1 GB
Soldered VRAM	See VRAM Note
Number of VRAM Slots	See VRAM Note
Cache DIMM Slot	No

See additional notes on the following page





DIMMs

Whereas SIMMs have 72-pins, DIMMs have 168 pins. The extra pins provide a 64-bit data path, compared to a 32-bit data path for SIMMs. In addition, DIMMs do not have to be installed in pairs like the SIMMs on earlier Macintosh models. (However, to take advantage of memory interleaving, the DIMMs should be installed in paired slots. See “DIMMs” in Miscellaneous for more information.)

Memory Configurations

The WS 9650 logic boards have 12 DRAM DIMM slots, each with a 64-bit data bus. You can increase the computer’s DRAM to 768 MB using 5-volt, 64-bit-wide, 168-pin fast-paged mode or EDO DIMMs.

When installing DRAM DIMMs in the WS 9650, fill slot A6 first, followed by B6, then A5, followed by B5, and so on. DRAM DIMMs can be installed individually; however, to take advantage of memory interleaving (see Note below), which provides maximum performance, you must install the DIMMs in matching pairs and in paired slots (A6 and B6 first, then A5 and B5, and so on).





Macintosh Server G3

The Macintosh Server G3 comes in two standard configurations as well as customer build-to-order configurations.

The 233MHz comes standard with 64 MB of SDRAM. The 266 MHz version comes standard with 128 MB of SDRAM. You can expand the total memory of both configurations to a maximum of 384 MB using 64-bit, JEDEC standard, 3.3 V, unbuffered SDRAM DIMMs.

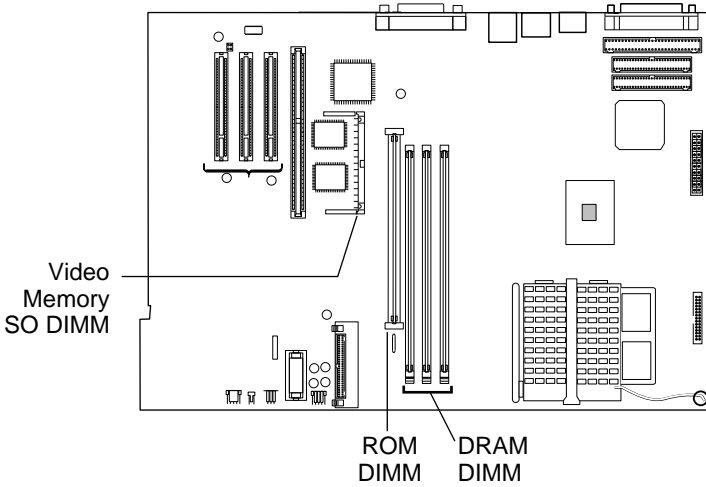

DRAM Configurations	
64 MB	The Macintosh Server G3 comes standard with 64 MB of SDRAM (one 64 MB DIMM).
128 MB	The 266 MHz Macintosh G3 Server comes standard with 128 MB of SDRAM (two 64 MB DIMMS).
Up to 384 MB	Use 4, 8, 16, 32, 64, or 128 MB 168-pin DIMMs.

Memory Information	
SDRAM Speed	10 ns
DIMM Type	168-pin
Soldered SDRAM	None
Number of DIMM Slots	3
Supported Sizes in MB	4, 8, 16, 32, 64, 128
Maximum SDRAM	384 MB
Virtual Memory	1 GB
Soldered Video Memory	2 MB SGRAM
Number of Video Memory Slots	1
Cache DIMM Slot	No

Note: SDRAM DIMMs can be installed one at a time and in any slot as there are no interleaving benefits.

Video Memory Note: The computer comes standard with 2 MB of SGRAM video memory. There is one video memory slot on the board that accepts up to a 4 MB SGRAM module for a maximum of 6 MB of video memory.





Portables

Macintosh Portable

The Macintosh Portable has 1 MB of soldered RAM, one expansion slot, and is expandable to 9 MB using a static RAM card.

Note: The Macintosh Portable uses Static RAM (SRAM).

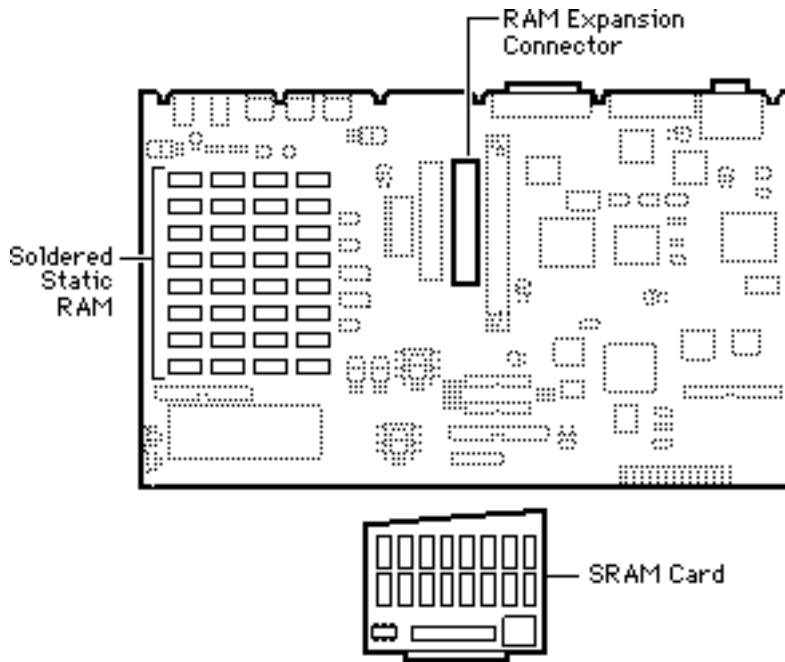

DRAM Configurations	
1 MB	The Macintosh Portable has 1 MB of soldered RAM.
2 MB	Install a 1 MB Static RAM Card (SRAM Card).
3 MB	Install a 2 MB Static RAM Card (SRAM Card).
4 MB	Install a 3 MB Static RAM Card (SRAM Card).
5 MB	Install a 4 MB Static RAM Card (SRAM Card).
6 MB	Install a 5 MB Static RAM Card (SRAM Card).
7 MB	Install a 6 MB Static RAM Card (SRAM Card).
8 MB	Install a 7 MB Static RAM Card (SRAM Card).
9 MB	Install an 8 MB Static RAM Card (SRAM Card).

Memory Information	
RAM Speed	100 ns
Soldered RAM	1 MB
Supported Sizes in MB	1-8
Maximum RAM	9 MB
Virtual Memory	No
Soldered VRAM	None
Number of VRAM Slots	None





Backlit Portable

The Backlit Portable has 1 MB of soldered RAM and is expandable to 8 MB using a Pseudostatic RAM card.

Note: The Backlit Portable uses Pseudostatic RAM (PSRAM).

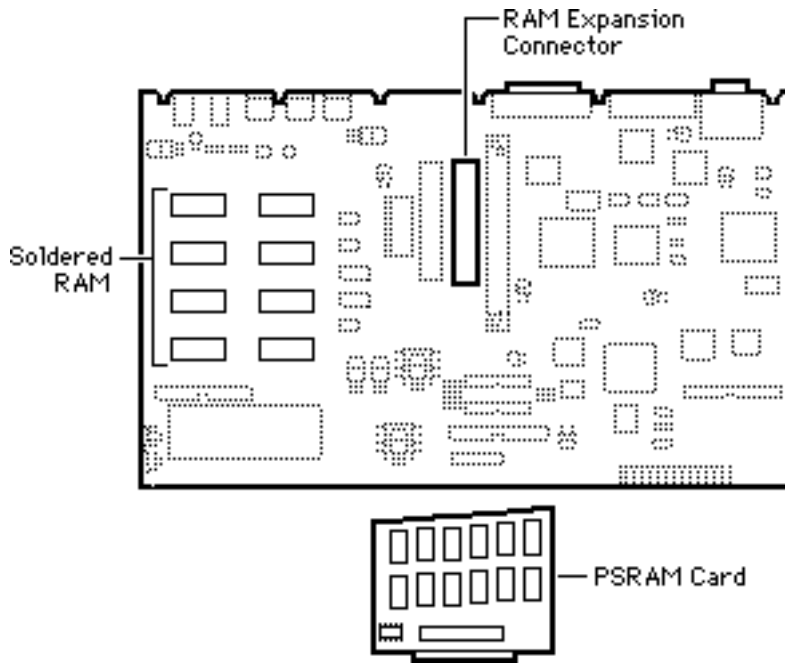

DRAM Configurations	
1 MB	The Macintosh Portable has 1 MB of soldered RAM.
2 MB	Install a 1 MB Static RAM Card (PSRAM Card).
3 MB	Install a 2 MB Static RAM Card (PSRAM Card).
4 MB	Install a 3 MB Static RAM Card (PSRAM Card).
5 MB	Install a 4 MB Static RAM Card (PSRAM Card).
6 MB	Install a 5 MB Static RAM Card (PSRAM Card).
7 MB	Install a 6 MB Static RAM Card (PSRAM Card).
8 MB	Install a 7 MB Static RAM Card (PSRAM Card).

Memory Information	
RAM Speed	100 ns
Soldered RAM	1 MB
Supported Sizes in MB	1 - 7
Maximum RAM	8 MB
Virtual Memory	No
Soldered VRAM	None
Number of VRAM Slots	None





PowerBook 100

The PowerBook 100 has 2 MB of soldered RAM, one expansion slot on the motherboard, and is expandable to 8 MB.

You must verify compatibility between any memory card and the PowerBook 100.

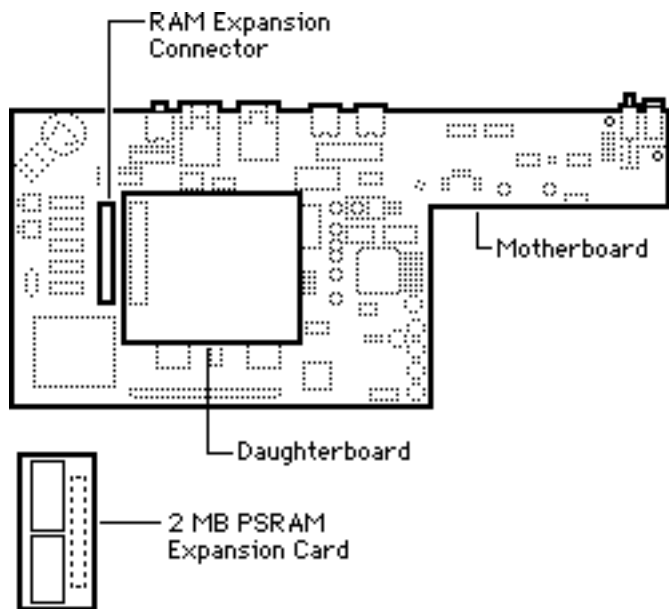

DRAM Configurations	
2 MB	The PowerBook 100 daughterboard has 2 MB of soldered PSRAM.
4 MB	Install a 2 MB Static RAM Card (PSRAM Card).
6 MB	Install a 4 MB Static RAM Card (PSRAM Card).
8 MB	Install a 6 MB Static RAM Card (PSRAM Card).

Memory Information	
RAM Speed	100 ns
Soldered RAM	2 MB
Supported Sizes in MB	n/a
Maximum RAM	8 MB
Virtual Memory	No
Soldered VRAM	None
Number of VRAM Slots	None





PowerBook 140/145

The PowerBook 140/145 has 2 MB of soldered RAM, one expansion slot on the daughterboard, and is expandable to 8 MB.

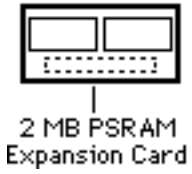
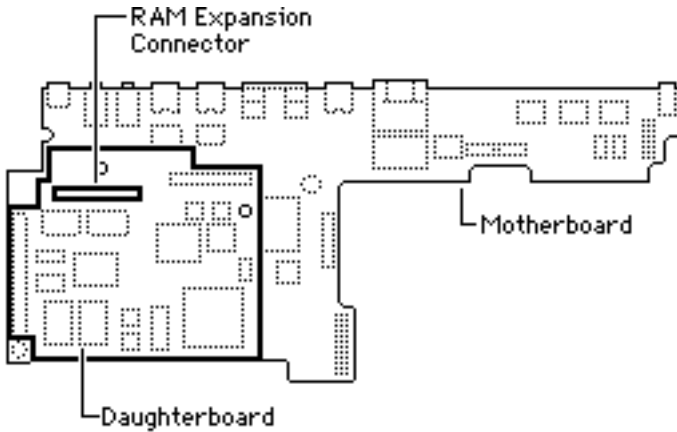

DRAM Configurations	
2 MB	The PowerBook 140/145 daughterboards have 2 MB of soldered PSRAM.
4 MB	Install a 2 MB Static RAM Card (PSRAM Card).
6 MB	Install a 4 MB Static RAM Card (PSRAM Card).
8 MB	Install a 6 MB Static RAM Card (PSRAM Card).

Memory Information	
RAM Speed	100 ns
Soldered RAM	2 MB
Supported Sizes in MB	2, 4, 6
Maximum RAM	8 MB
Virtual Memory	Yes
Soldered VRAM	None
Number of VRAM Slots	None





PowerBook 145B

The 145B has 4 MB of soldered RAM, one expansion slot on the daughterboard, and is expandable to 8 MB.

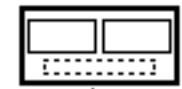
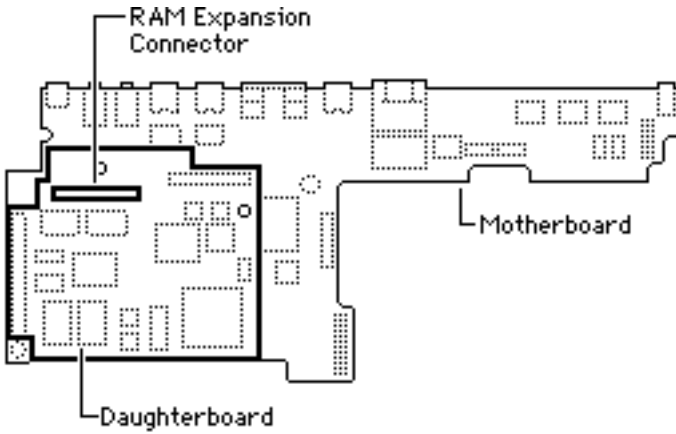

2 MB PSRAM Expansion Card

DRAM Configurations	
4 MB	The PowerBook 145B daughterboard has 4 MB of soldered PSRAM.
6 MB	Install a 2 MB Static RAM Card (PSRAM Card).
8 MB	Install a 4 MB Static RAM Card (PSRAM Card).

Memory Information	
RAM Speed	100 ns
Soldered RAM	2 MB
Supported Sizes in MB	4, 6, 8
Maximum RAM	8 MB
Virtual Memory	1 GB
Soldered VRAM	None
Number of VRAM Slots	None





PowerBook 150

The PowerBook 150 has 4 MB of soldered RAM, one expansion connector, and is expandable to 40 MB.

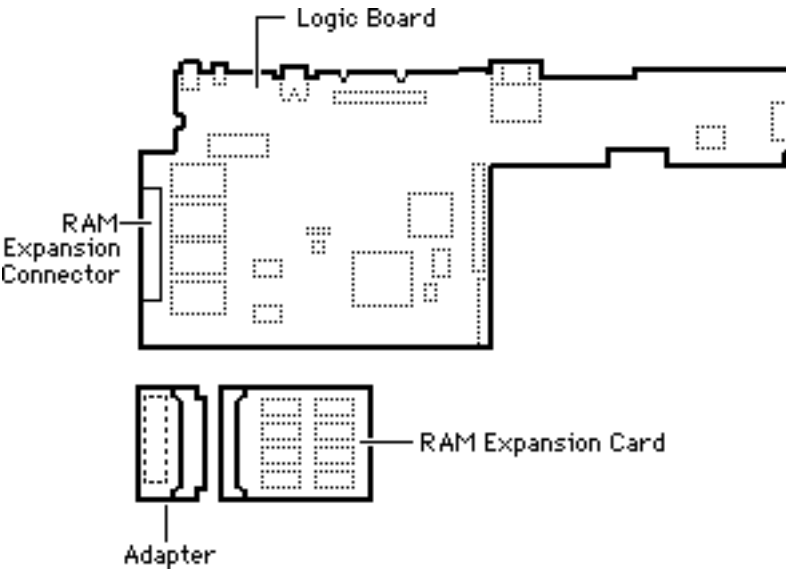

DRAM Configurations	
4 MB	The PowerBook 150 logic board has 4 MB of soldered DRAM.
Up to 40 MB	Install a Duo RAM Expansion Card and adapter for up to 40 MB.

Note: You must use an adapter to install additional memory. The part number for the adapter is M3179LL/A.

Memory Information	
RAM Speed	70 ns
Soldered RAM	4 MB
Supported Sizes in MB	Up to 36 MB
Maximum RAM	40 MB
Virtual Memory	1 GB
Soldered VRAM	None
Number of VRAM Slots	None





PowerBook 170

The PowerBook 170 has 2 MB of soldered RAM, one expansion slot on the daughterboard, and is expandable to 8 MB.

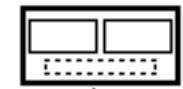
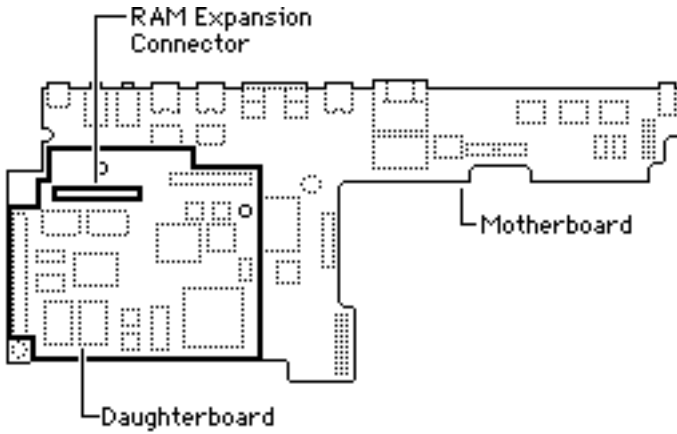

2 MB PSRAM Expansion Card

DRAM Configurations	
2 MB	The PowerBook 170 daughterboard has 2 MB of soldered PSRAM.
4 MB	Install a 2 MB Static RAM Card (PSRAM Card).
6 MB	Install a 4 MB Static RAM Card (PSRAM Card).
8 MB	Install a 6 MB Static RAM Card (PSRAM Card).

Memory Information	
RAM Speed	100 ns
Soldered RAM	2 MB
Supported Sizes in MB	4, 6
Maximum RAM	8 MB
Virtual Memory	1 GB
Soldered VRAM	None
Number of VRAM Slots	None





PowerBook 160/165/180

The PowerBook 160/165/180 has 4 MB of soldered RAM, one expansion slot on the daughterboard, and is expandable to 14 MB.

Note: The memory expansion connector is keyed. Do not force the card onto the daughterboard.

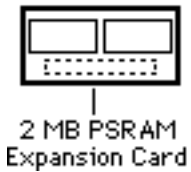
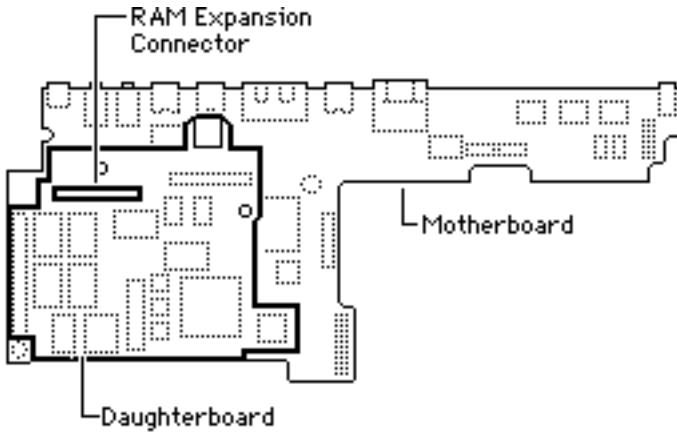

DRAM Configurations	
4 MB	The PowerBook 160/165/180 daughterboard has 4 MB of soldered PSRAM.
6 MB	Install a 2 MB Static RAM Card (PSRAM Card).
8 MB	Install a 4 MB Static RAM Card (PSRAM Card).
10 MB	Install a 6 MB Static RAM Card (PSRAM Card).
12 MB	Install an 8 MB Static RAM Card (PSRAM Card).
14 MB	Install a 10 MB Static RAM Card (PSRAM Card).

Memory Information	
RAM Speed	85 ns (see Note)
Soldered RAM	4 MB
Supported Sizes in MB	4, 8
Maximum RAM	14 MB
Virtual Memory	1 GB
Soldered VRAM	512k
Number of VRAM Slots	None

Note: To avoid adding wait states to the PowerBook 160/165/180, you **must** use 85ns FAST RAM. The addition of the wait state can cause a 10% to 15% decrease in performance.





PowerBook 165c/180c

The PowerBook 165c and 180c have 4 MB of soldered RAM, one expansion slot on the daughterboard, and are expandable to 14 MB.

Note: The memory expansion connector is keyed. Do not force the card onto the daughterboard.

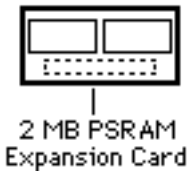
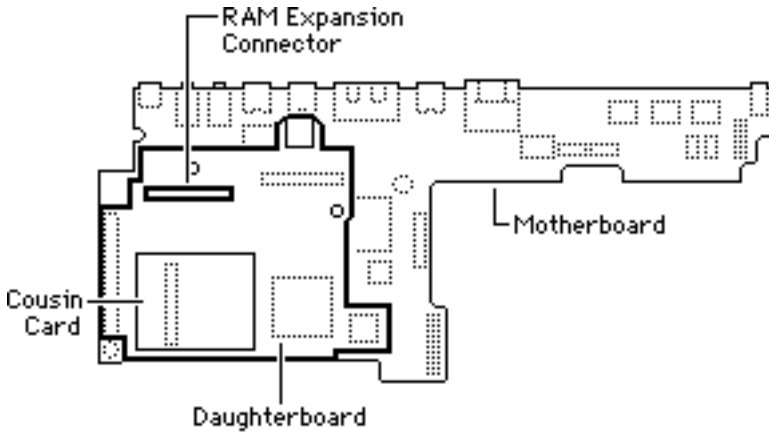

DRAM Configurations	
4 MB	The PowerBook 165c/180c daughterboard has 4 MB of soldered PSRAM.
6 MB	Install a 2 MB Static RAM Card (PSRAM Card).
8 MB	Install a 4 MB Static RAM Card (PSRAM Card).
10 MB	Install a 6 MB Static RAM Card (PSRAM Card).
12 MB	Install an 8 MB Static RAM Card (PSRAM Card).
14 MB	Install a 10 MB Static RAM Card (PSRAM Card).

Memory Information	
RAM Speed	85 ns (see Note)
Soldered RAM	4 MB
Supported Sizes in MB	4, 6, 8, 10
Maximum RAM	14 MB
Virtual Memory	1 GB
Soldered VRAM	512k
Number of VRAM Slots	None

Note: To avoid adding wait states to the PowerBook 165c/180c, you **must** use 85 ns FAST RAM. The addition of the wait state can cause a 10% to 15% decrease in performance.





PowerBook 190/190cs

The PowerBook 190 and 190cs come with either 4 or 8 MB of RAM soldered onto the main logic board, one expansion slot each, and are expandable to 36 or 40 MB of RAM respectively.

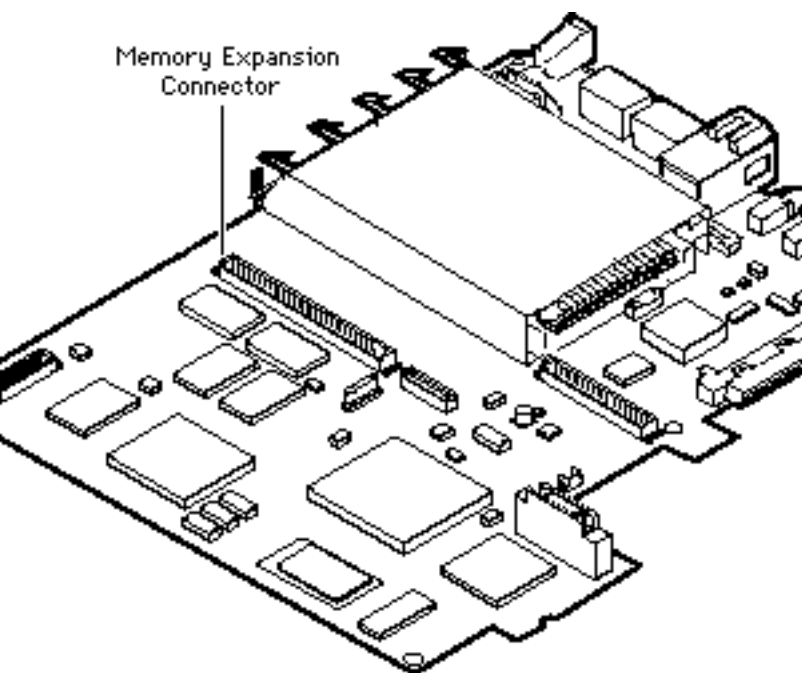

DRAM Configurations	
4/8 MB	The PowerBook 190 and 190cs come with either 4 or 8 MB of RAM soldered on the main logic board.
Up to 36/40 MB	Install a 4, 8, 16 or 32 MB Expansion Card.

Memory Information	
RAM Speed	70 ns
Soldered RAM	4 or 8 MB
Supported Sizes in MB	4, 8, 16, 32 MB
Maximum RAM	36/40 MB
Virtual Memory	1 GB
Soldered VRAM	See VRAM Note
Number of VRAM Slots	See VRAM Note

VRAM Note: The highest bit depth available for external displays at either 640x480 or 832x624 resolutions is 8 bits per pixel unless you expand the VRAM by replacing the Apple video-out card with a third-party video expansion card product. If the VRAM on the third-party video card is 1 MB, the computer will be able to output 16-bits per pixel on an external display.

Note: The PowerBook 190 (with the video-out upgrade) has 512K of VRAM soldered on a video card for supporting external displays. The PowerBook 190 (with the video-out upgrade) has two separate sets of VRAM to support the internal and external displays.





PowerBook Duo 210/230

The PowerBook Duo 210 and 230 have 4 MB of RAM soldered on-board and are expandable to 24 MB.

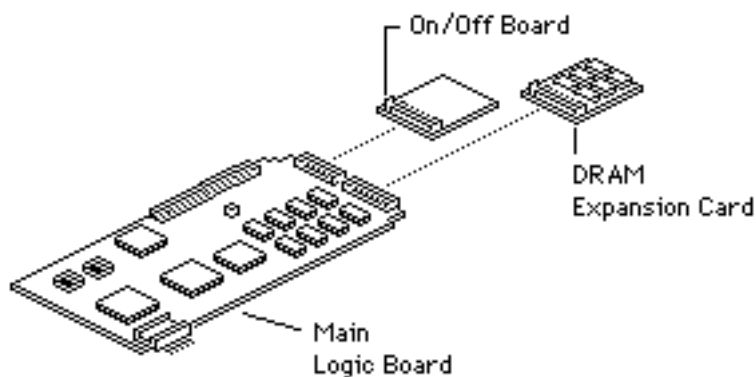

DRAM Configurations	
4 MB	The PowerBook Duo 210/230 logic board has 4 MB of soldered DRAM.
Up to 24 MB	Install a 4, 8, 16 or 20 MB Expansion Card.

Memory Information	
RAM Speed	70 ns
Soldered RAM	4 MB
Supported Sizes in MB	4, 6, 8, 10,12, 14, 16, 20
Maximum RAM	24 MB
Virtual Memory	1 GB
Soldered VRAM	None
Number of VRAM Slots	None

Note: Apple supplies 4 MB and 8 MB PSRAM Expansion Cards. Other sizes are available from third-party vendors.





PowerBook Duo 250

The PowerBook Duo 250 has 4 MB of RAM soldered on-board and is expandable to 24 MB.

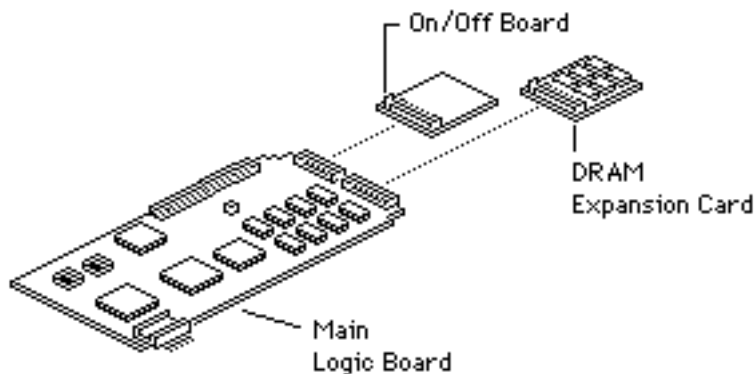

DRAM Configurations	
4 MB	The PowerBook Duo 250 logic board has 4 MB of soldered DRAM.
Up to 24 MB	Install a 4, 6, 8, 10, 12, 16 or 20 MB Expansion Card.

Memory Information	
RAM Speed	70 ns
Soldered RAM	4 MB
Supported Sizes in MB	4, 6, 8, 10, 12, 16, 20
Maximum RAM	24 MB
Virtual Memory	1 GB
Soldered VRAM	None
Number of VRAM Slots	None

Note: Apple supplies 4 MB and 8 MB PSRAM Expansion Cards. Other sizes are available from third-party vendors.





PowerBook Duo 270c

The PowerBook Duo 270c has 4 MB of RAM soldered on-board and is expandable to 32 MB.

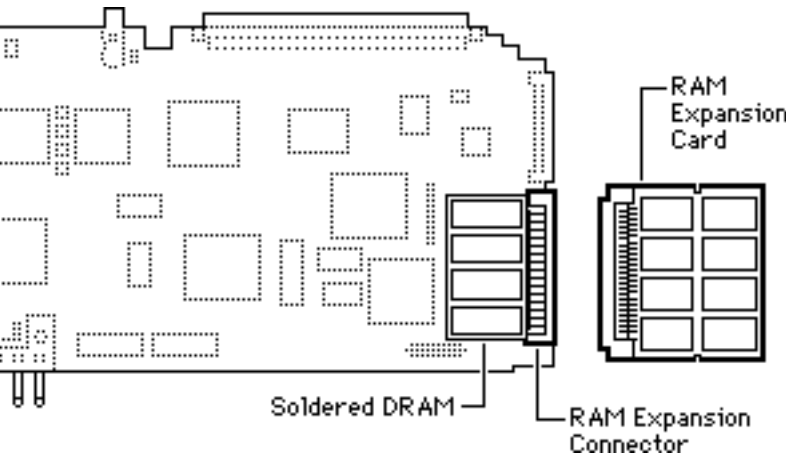

DRAM Configurations	
4 MB	The PowerBook Duo 270c logic board has 4 MB of soldered DRAM.
Up to 32 MB	Install a 4, 6, 8, 10, 12, 16 or 20 MB Expansion Card.

Memory Information	
RAM Speed	70 ns
Soldered RAM	4 MB
Supported Sizes in MB	4, 6, 8, 10, 12, 16, 20 (see Note)
Maximum RAM	32 MB (see Note)
Virtual Memory	1 GB
Soldered VRAM	None
Number of VRAM Slots	None

Note: Apple supplies 4 MB and 8 MB PSRAM Expansion Cards. Other sizes are available from third-party vendors.





PowerBook Duo 280/280c

The PowerBook Duo 280 and 280c have 4 MB of RAM soldered on-board and are expandable to 40 MB.

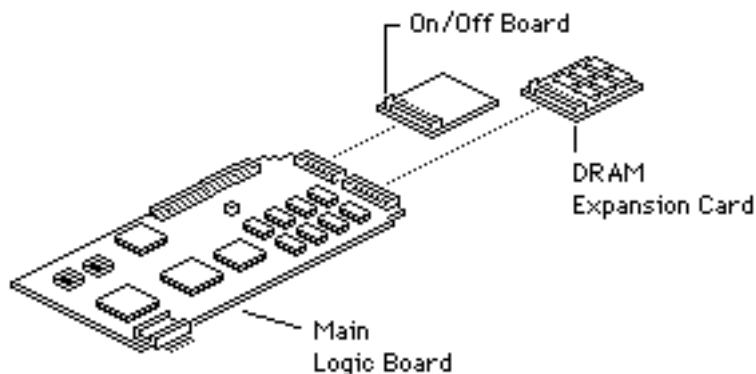

DRAM Configurations	
4 MB	The PowerBook Duo 280 and 280c have 4 MB of RAM soldered on-board and one expansion slot.
Up to 40 MB	Install a 4, 6, 8, 10, 12, 16, 20, 24 or 36 MB Expansion Card.

Memory Information	
RAM Speed	70 ns
Soldered RAM	4 MB
Supported Sizes in MB	4, 6, 8, 10, 12, 16, 20, 24, 36 (see Note)
Maximum RAM	40 MB
Virtual Memory	1 GB
Soldered VRAM	None
Number of VRAM Slots	None

Note: Both units will support a maximum of 40 MB of memory with use of a third-party 36 MB memory card. A 24 MB card is also supported.

Note: Apple supplies an 8 MB PSRAM Expansion Card. Other sizes are available from third-party vendors.





PowerBook 520/540

The PowerBook 520, 520c, 540, and 540c have 4 MB of RAM soldered on-board and one expansion slot each. These computers are expandable to 36 MB of RAM.

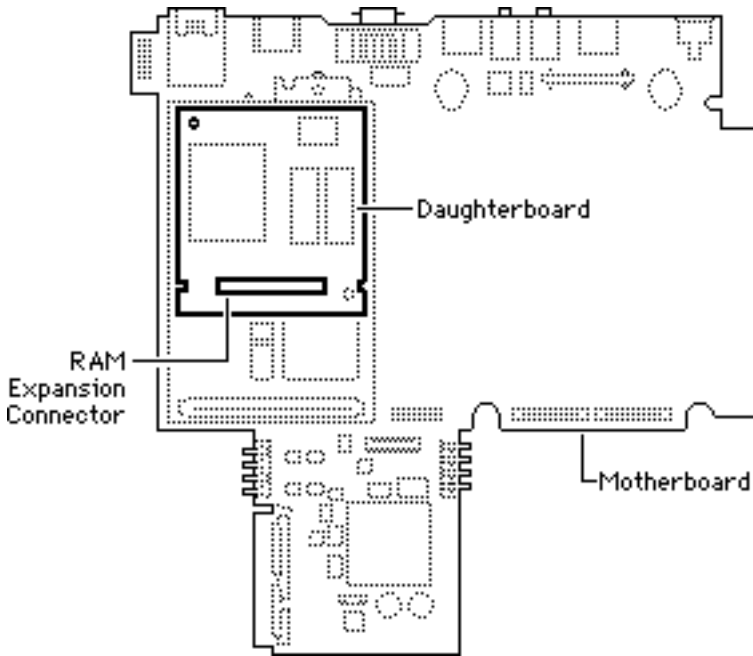

DRAM Configurations	
4 MB	The PowerBook 520/540 daughterboard has 4 MB of soldered DRAM.
8 MB	Install a 4 MB Static RAM Card (PSRAM Card).
12 MB	Install an 8 MB Static RAM Card (PSRAM Card).
36 MB	Install a 32 MB Static RAM Card (PSRAM Card).

Memory Information	
RAM Speed	70 ns
Soldered RAM	4 MB
Supported Sizes in MB	4, 8, 12, 20, 32
Maximum RAM	36 MB
Virtual Memory	1 GB
Soldered VRAM	512K (see Note)
Number of VRAM Slots	None

Note: There is 512K of VRAM available for internal and external video for a total of 1 MB. It is not expandable.

Note: Apple does not supply 32 MB PSRAM Expansion Cards; however, they are available from third-party vendors.





PowerBook 1400 Series

The information presented here is valid for PowerBook:

- 1400cs
- 1400c
- 1400c/133
- 1400cs/133
- 1400c/166
- 1400cs/166

The PowerBook 1400 ships with a minimum of 12 MB of low-power DRAM. You can expand the memory to a total of 64 MB using TSOP low-profile RAM chips rated at 70 ns or faster.

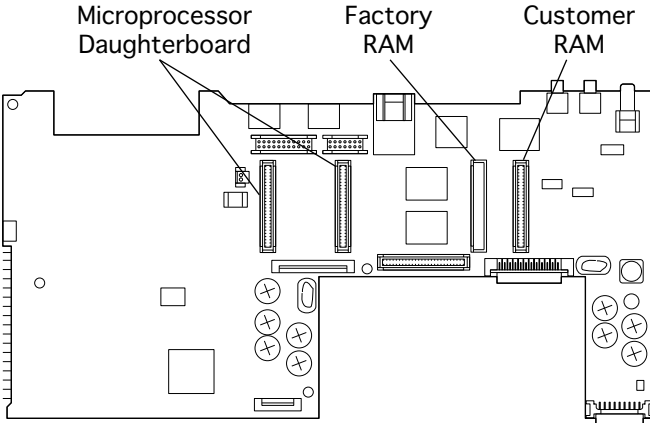

DRAM Configurations	
12 MB	The PowerBook 1400 minimum configuration has 8 MB of factory DRAM and a 4 MB RAM card in the customer RAM slot.
16 MB	The 16 MB configuration has 8 MB of customer DRAM and an 8 MB RAM card in the factory RAM slot.
24 MB	Upgrade the 16 MB configuration by installing an 8 MB RAM card in the customer RAM slot.
32 MB	Upgrade the 16 MB configuration by installing two 8 MB RAM cards in the customer RAM slot.

Memory Information	
RAM Speed	70 ns
Minimum RAM	8 MB or 16 MB
Supported Sizes in MB	4, 8, 12, 20, 32
Maximum RAM	64 MB
Virtual Memory	1 GB
Soldered VRAM	1 MB
Number of VRAM Slots	N/A

Note: Apple does not supply 32 MB PSRAM Expansion Cards; however, they are available from third-party vendors.

Note: A minimum of 16 MB RAM is provided in PowerBooks 1400cs/133, 1400c/166, and 1400cs/166.





PowerBook 2300 Series

The PowerBook 2300c has 8 MB of RAM soldered on-board, one expansion slot, and is expandable to 56 MB.

The 8 MB configuration as shipped from Apple has no RAM expansion card installed, while the 20 MB configuration has a 12 MB expansion card installed.

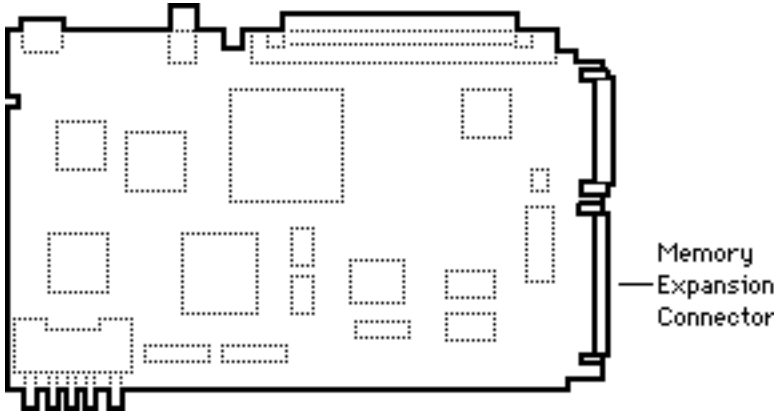

DRAM Configurations	
8 MB	The PowerBook 2300c has 8 MB of RAM on the main logic board and one expansion slot.
Up to 56 MB	Install an appropriate Expansion Card.

Memory Information	
RAM Speed	70 ns
Soldered RAM	8 MB
Maximum RAM	56 MB
Virtual Memory	1 GB
Soldered VRAM	1 MB
Number of VRAM Slots	N/A





PowerBook 2400c

The PowerBook 2400c has 16 MB of EDO RAM soldered on-board, one expansion slot, and is expandable to 48 MB.



RAM Card

DRAM Configurations	
16 MB	The PowerBook 2300c has 16 MB of EDO RAM on the main logic board and one expansion slot.
Up to 48 MB	Install an appropriate Expansion Card.

Memory Information	
RAM Speed	70 ns
Soldered RAM	16 MB
Maximum RAM	48 MB
Virtual Memory	1 GB
Soldered VRAM	1 MB
Number of VRAM Slots	N/A





PowerBook 5300 series

The PowerBook 5300cs and 5300c come with either 8 or 16 MB of RAM soldered on-board. Either configuration is expandable to 64 MB of RAM.

The PowerBook 5300ce comes with a 16 MB expansion card installed.

Note: All of the PowerBook 5300 series computers have two separate sets of VRAM to support the internal and external displays.

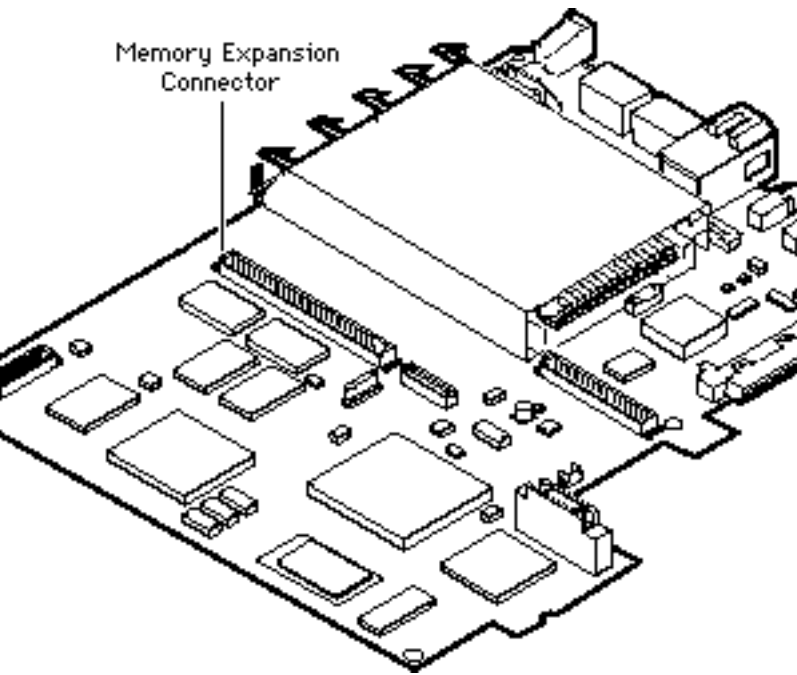

DRAM Configurations	
Up to 64 MB	Install an appropriate Expansion Card.

Memory Information	
RAM Speed	70 ns
Soldered RAM	8 or 16 MB
Maximum RAM	64 MB
Virtual Memory	1 GB
Soldered VRAM	See VRAM note
Number of VRAM Slots	See VRAM note

Internal Display VRAM Note: The following descriptions apply only to models sold in the United States. Europe and Asia have models that differ slightly from these configurations.

The Macintosh PowerBook 5300 and 5300cs computers and the 5300c (that comes with 8 MB of RAM) come with 512K of VRAM soldered to the logic board for support of the internal LCD Display. It cannot be removed or upgraded.

The Macintosh PowerBook 5300c that comes with 16 MB of RAM on the logic board and the Macintosh PowerBook 5300ce have 1 MB of VRAM. This allows for higher bit depth support on the internal display. This VRAM cannot be removed or upgraded. If necessary, please refer to the Service Parts Database for proper identification.

Note: The PowerBook 5300 series computers have 512K of VRAM soldered onto a video card for supporting external displays. The highest bit depth available for external displays at either 640x480 or 832x624 resolutions is 8 bits per pixel unless you expand the VRAM by replacing the Apple video-out card with a third-party video expansion card product. If the VRAM on the third-party video card is 1 MB, the computer will be able to output 16-bits per pixel on an external display.





PowerBook 3400 Series

The PowerBook 3400 Series comes with 16 MB of RAM on the logic board. One RAM expansion slot can accommodate a single card of up to 128 MB for a total of 144 MB.

Note: The 5300/190 series RAM will not work in the PowerBook 3400 Series. The DRAM connector is similar, but some pin addresses have been changed and the connector has been rotated 180 degrees.

(Front)

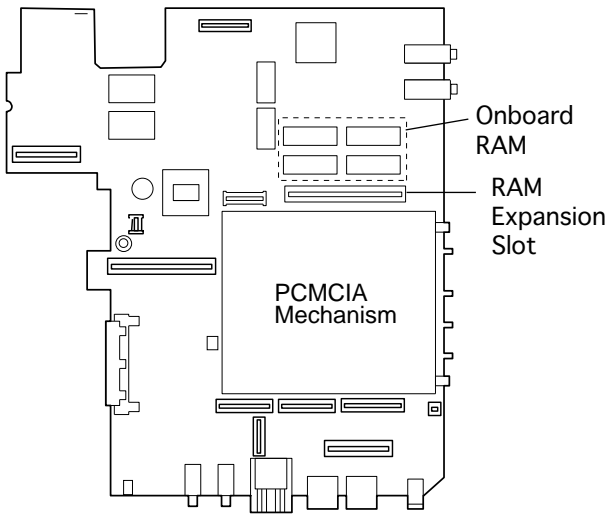

DRAM Configurations	
16 MB	The PowerBook 3400 series has 16 MB of RAM on the main logic board.
Up to 144 MB	One RAM expansion slot can accommodate a single card of up to 128 MB for a total of 144 MB. Install an appropriate Expansion Card.

Memory Information	
RAM Speed	60 ns
RAM Type	EDO
Soldered RAM	16 MB
Maximum RAM	144 MB
Virtual Memory	1 GB
Soldered VRAM	1 MB
Number of VRAM Slots	N/A





PowerBook G3

The PowerBook G3 comes with 32 MB of RAM on the logic board. One RAM expansion slot can accommodate a single card of up to 128 MB for a total of 160 MB.

Note: RAM expansion cards must use EDO 3.3 volt RAM chips rated at 60 ns or faster, and must have TSOP low-profile RAM chips only. Installing a card with high-profile chips may damage the computer.

(Front)

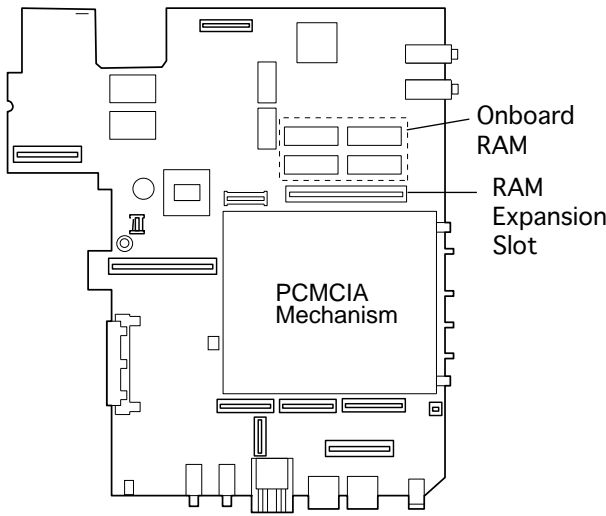

DRAM Configurations	
32 MB	The PowerBook G3 has 32 MB of RAM on the main logic board.
Up to 160 MB	One RAM expansion slot can accommodate a single card of up to 128 MB for a total of 160 MB. Install an appropriate Expansion Card.

Memory Information	
RAM Speed	60 ns
RAM Type	EDO
Soldered RAM	32 MB
Maximum RAM	160 MB
Virtual Memory	1 GB
Soldered VRAM	2 MB
Number of VRAM Slots	N/A





PowerBook G3 Series

The PowerBook G3 Series comes with a minimum of 32 MB of RAM on the underside slot of the microprocessor board. One RAM expansion slot can accommodate a single card of up to 128 MB for a total of 192 MB.

Note: The microprocessor board has two memory card slots. The top slot is the user-replaceable slot (128 MB only in top slot). The slot on the underside of the board is used by the factory.

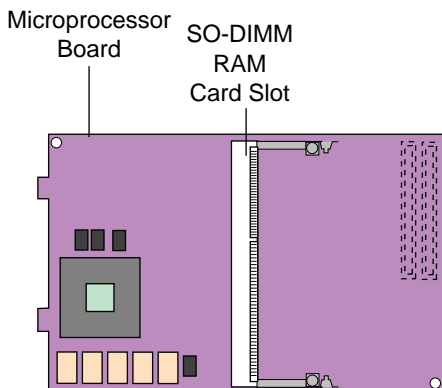

DRAM Configurations	
32 MB	The PowerBook G3 Series has a minimum of 32 MB of RAM on the lower slot of the microprocessor board.
Up to 192 MB	One RAM expansion slot can accommodate a single card of up to 128 MB for a total of 192 MB. 128 MB SO-DIMM (1.5-inch wide card) required in top slot for space reasons.

Memory Information	
RAM Speed	10 ns
RAM Type	SDRAM
Minimum RAM	32 MB
Maximum RAM	192 MB
Virtual Memory	1 GB
Soldered Video SGRAM	
12.1-inch Display	2 MB
13.3-inch Display	4 MB
14.1-inch Display	4 MB
Number of VRAM Slots	N/A





Laser Printers



LaserWriter II NTX/NTX-J

The LaserWriter II NTX/NTX-J has no soldered DRAM. A maximum of 12 MB of DRAM is possible; however, a 6 MB configuration is not supported.

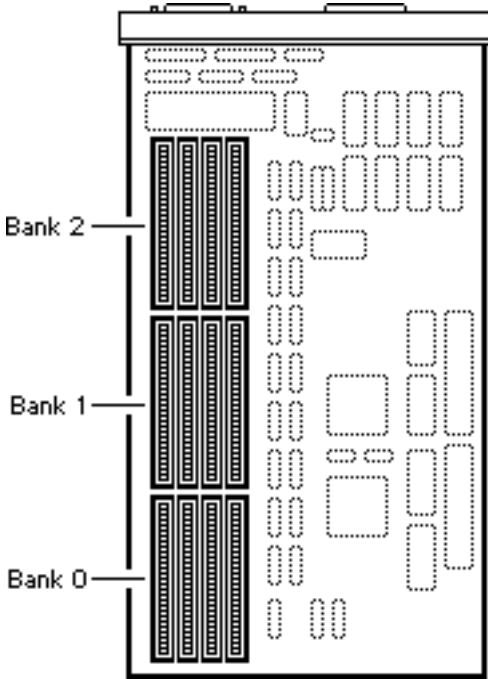

DRAM Configurations			
Total Memory	Install Four in Bank 0	Install Four in Bank 1	Install Four in Bank 2
2 MB	256K	256K	Empty
3 MB	256K	256K	256K
4 MB	1 MB	Empty	Empty
5 MB	1 MB	256K	Empty
8 MB	1 MB	1 MB	Empty
9 MB	1 MB	1 MB	256K
12 MB	1 MB	1 MB	1 MB

Memory Information	
DRAM Speed	120 ns
SIMM Type	64-pin
Soldered DRAM	None
Expansion Sockets	4
Supported Sizes	256K, 1 MB
Maximum DRAM	12 MB

Note: The 2 MB and 3 MB configurations are only supported by the LaserWriter II NTX.

Note: Install memory with the highest density SIMMs in Bank 0 first.





LaserWriter II SC

The LaserWriter II SC has 512K of DRAM soldered on-board. Total DRAM can be expanded to 1 MB.

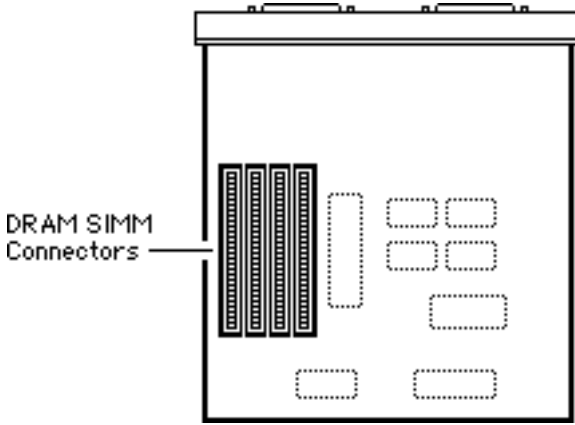

DRAM Configurations	
1 MB	Install four 256K SIMMs.

Memory Information	
DRAM Speed	120 ns
SIMM Type	64-pin
Soldered DRAM	512K
Expansion Sockets	4
Supported Sizes in MB	256
Maximum DRAM	1 MB





LaserWriter II_f/II_g

The LaserWriter II_f and II_g have no soldered DRAM. Total DRAM can be expanded to 32 MB.

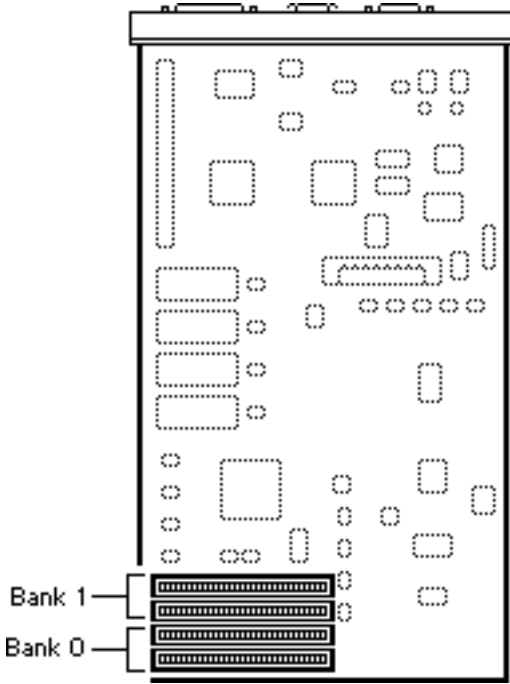

DRAM Configurations		
Total Memory	Install Four in Bank 0	Install Four in Bank 1
2 MB	256K	256K
4 MB	1 MB	Empty
5 MB	1 MB	256K
8 MB	1 MB	1 MB
16 MB	4 MB	Empty
17 MB	4 MB	256K
20 MB	4 MB	1 MB
32 MB	4 MB	4 MB

Memory Information	
DRAM Speed	80 ns
SIMM Type	30-pin
Soldered DRAM	none
Expansion Sockets	8
Supported Sizes in MB	256, 1, 4
Maximum DRAM	32 MB

Note: The 2 MB and 4 MB configurations are only supported by the LaserWriter II_f.





Personal LaserWriter 320

The Personal LaserWriter 320 has 2 MB of soldered DRAM. DRAM is expandable via 2 MB and 6 MB expansion cards, which allow for total memory configurations of 4 MB or 8 MB.

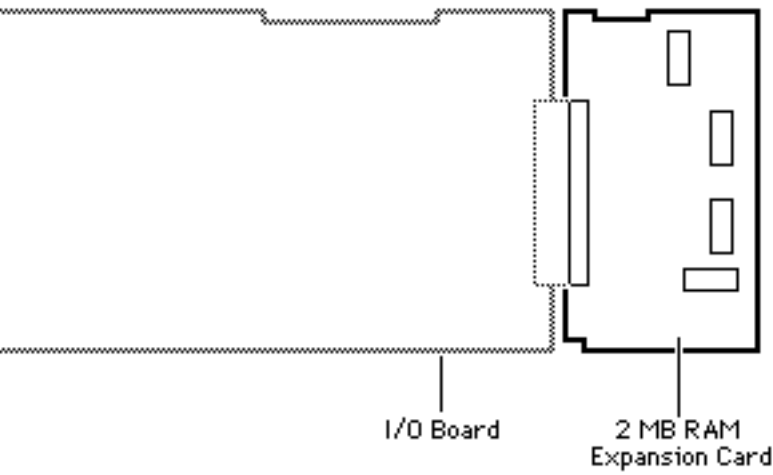

DRAM Configurations	
2 MB	The Personal LaserWriter 320 logic board has 2 MB of soldered DRAM.
4 MB	Install 2 MB RAM Expansion Card into connector on Personal LaserWriter 320 I/O board to bring total DRAM to 4 MB.
8 MB	Install 6 MB RAM Expansion Card into connector on Personal LaserWriter 320 I/O board to bring total DRAM to 8 MB.

Memory Information	
DRAM Speed	N/A
SIMM Type	N/A
Soldered DRAM	2 MB
Expansion Sockets	One





Personal LaserWriter NT

The Personal LaserWriter NT has no soldered DRAM but ships with two 1 MB DRAM SIMMs installed. Total DRAM is expandable to 8 MB.

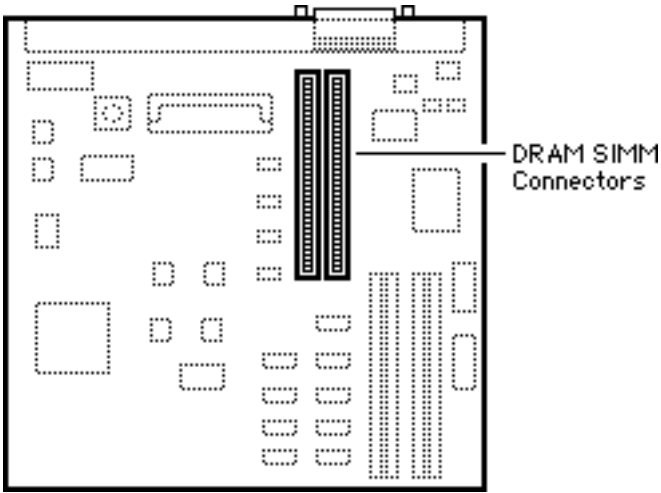

DRAM Configurations	
2 MB	The Personal LaserWriter NT comes with 2 MB of DRAM.
8 MB	Install two 4 MB SIMMs.

Memory Information	
DRAM Speed	120 ns
SIMM Type	30-pin
Soldered DRAM	None
Expansion Sockets	2
Supported Sizes in MB	1, 4
Maximum DRAM	8 MB





Personal LaserWriter SC

The Personal LaserWriter SC has no soldered DRAM. Total DRAM is expandable to 1 MB via four 120 ns or faster, 256K SIMMs.

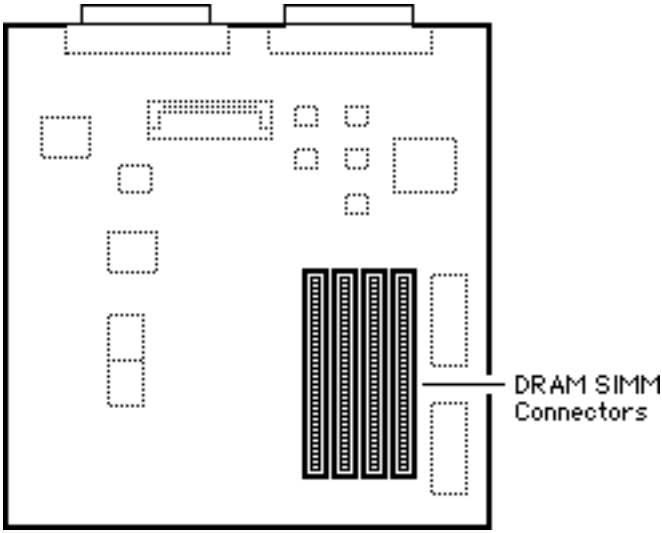

DRAM Configurations	
1 MB	Install four 256K SIMMs.

Memory Information	
DRAM Speed	120 ns
SIMM Type	30-pin
Soldered DRAM	none
Expansion Sockets	4
Supported Sizes in MB	256
Maximum DRAM	1 MB





Personal LaserWriter NTR

The Personal LaserWriter NTR ships with 3 MB of DRAM: 2 MB is soldered to the logic board and 1 MB is provided via a SIMM. Upgrading to 4 MB can be accomplished by replacing the 1 MB SIMM with a 2 MB SIMM.

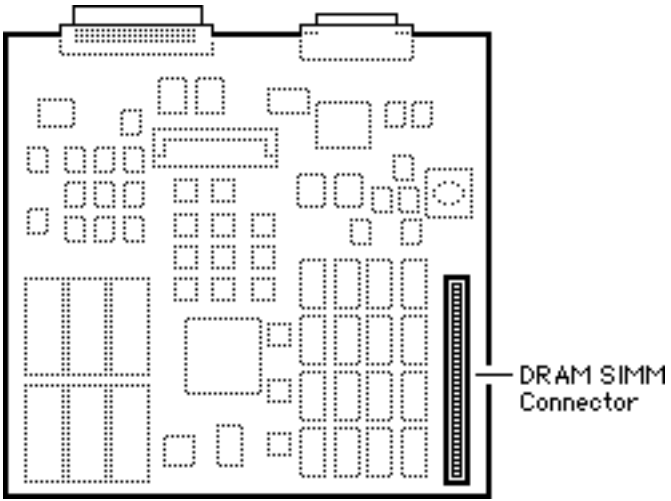

DRAM Configurations	
3 MB	The Personal LaserWriter NTR comes standard with 3 MB of DRAM, 2 MB soldered to the logic board and one 1 MB SIMM installed.
4 MB	Replace the 1 MB SIMM with a 2 MB SIMM.

Memory Information	
DRAM Speed	80 ns
SIMM Type	72-pin
Soldered DRAM	2 MB
Expansion Sockets	1
Supported Sizes in MB	1, 2
Maximum DRAM	4 MB





LaserWriter Pro 600/630

The LaserWriter 600/630 has no soldered memory. You can expand the memory to a total of 32 MB.

Some versions of the printer shipped with 4 MB of DRAM and a 4 MB upgrade kit, providing a total of 8 MB of DRAM.

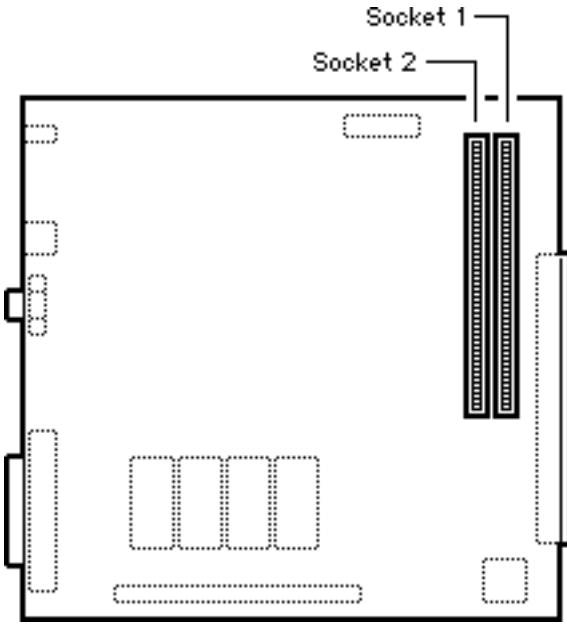

DRAM Configurations		
Total Memory	Install in Socket 1	Install in Socket 2
4 MB	4 MB	Empty
8 MB	4 MB	4 MB
8 MB	8 MB	Empty
16 MB	16 MB	Empty
20 MB	16 MB	4 MB
32 MB	16 MB	16 MB

Memory Information	
DRAM Speed	80 ns
SIMM Type	72-pin
Soldered RAM	none
Expansion Sockets	2
Supported Sizes in MB	4, 8, 16
Maximum DRAM	32 MB

Note: Apple manufactures many LaserWriter Pro printers with one double-sided 8 MB memory SIMM. To increase memory, you must first remove the 8 MB SIMM and then insert the desired memory SIMMs into the printer.

Note: When you add memory to a LaserWriter Pro, you must fill Bank 1 before Bank 2. If you have SIMMs of two different sizes, you must put the SIMM with the greater amount of memory in Bank 1.

(See additional Notes on following page.)

Note: The LaserWriter Pro 600 and 630 printers use industry standard 72-pin fast mode 80 ns SIMMs. Each printer has two banks.





Memory Upgrade Notes

You may use 4 MB, 8 MB, or 16 MB DRAM SIMMs in the LaserWriter Pro printers. All 8 MB SIMMs currently produced are considered double-sided SIMMs, since they have memory chips on both sides.

If you have a double-sided SIMM in one memory bank, the other memory bank must be left empty. The second memory bank cannot contain a SIMM. This restriction is inherent in the design of the LaserWriter Pro I/O Controller board.

When a double-sided SIMM is installed in one bank, each side of the SIMM is treated electrically as an individual bank. Since the LaserWriter Pro printers can only have two banks of memory, the second bank is unusable and you cannot insert a memory SIMM into it.





LaserWriter Pro 810

The LaserWriter Pro 810 ships with 8 MB of soldered memory. You can expand the memory to a total of 32 MB by installing Memory Expansion boards.

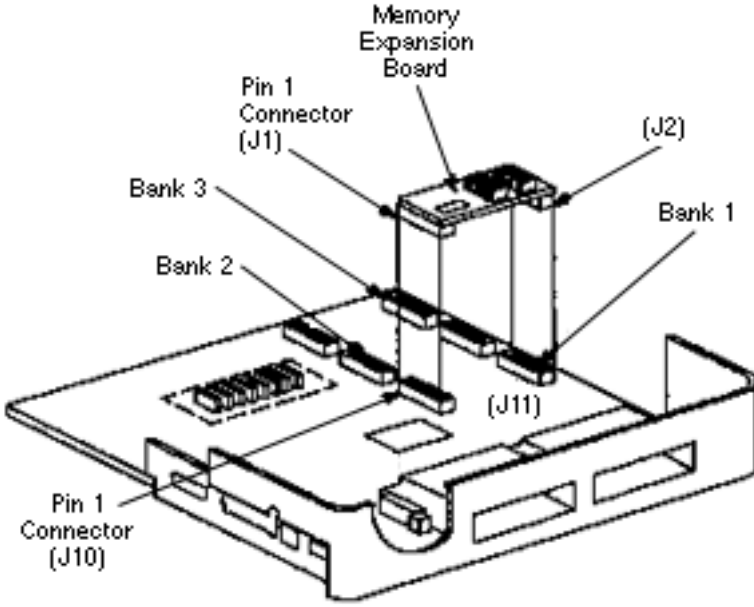

Note: Once you have upgraded your printer's memory, you need to reconfigure the printer driver to take advantage of the additional memory as follows:

- 1) Open the Chooser's Setup box.
- 2) Click More Choices in the Setup box.
- 3) Click Configure.
- 4) Choose the options installed on your printer and click OK.

DRAM Configurations			
Total Memory	Bank 1	Bank 2	Bank 3
8 MB	Empty	Empty	Empty
12 MB	4 MB	Empty	Empty
16 MB	4 MB 8 MB	4 MB Empty	Empty Empty
20 MB	4 MB 8 MB	4 MB 4 MB	4 MB Empty
24 MB	8 MB 8 MB	4 MB 8 MB	4 MB Empty
28 MB	8 MB	8 MB	4 MB
32 MB	8 MB	8 MB	8 MB

Note: Always fill the lowest numbered banks first. It doesn't matter in what order the 4 MB or 8 MB memory boards are installed as long as the lower banks are filled first.

Note: You cannot use RAM from another laser printer with a LaserWriter Pro 810. The LaserWriter Pro 810 uses special Memory Expansion boards.





LaserWriter 16/600 PS

The LaserWriter 16/600 PS has no soldered DRAM. You can expand the memory to a total of 32 MB.

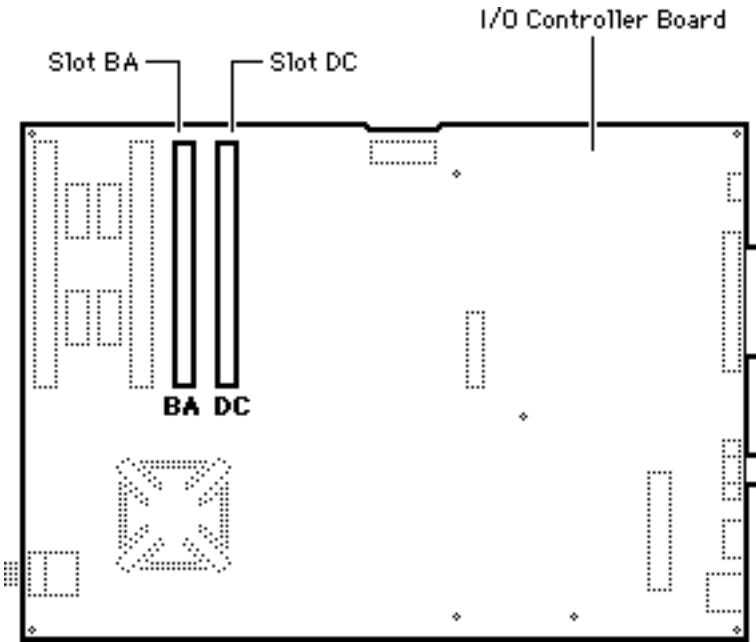

DRAM Configurations		
Total Memory	Install in Slot BA	Install in Slot DC
8 MB	8 MB	Empty
12 MB	8 MB	4 MB
16 MB	8 MB	8 MB
24 MB	16 MB	8 MB
32 MB	16 MB	16 MB

Memory Information	
DRAM Speed	80 ns
SIMM Type	72-pin
Soldered DRAM	none
Expansion Sockets	2
Supported Sizes in MB	4, 6, 8
Maximum DRAM	32 MB

Note: 8 MB of DRAM is the standard configuration shipped from Apple.

Note: 12 MB of DRAM is the standard configuration for enabling PhotoGrade.

Note: The 24 MB configuration requires moving the base 8MB SIMM from the left to the right SIMM slot. Due to space constraints, the left SIMM should always be installed before the right SIMM.

Note: The 32 MB configuration requires that you remove the standard 8 MB SIMM.

Note: The 16 MB SIMMs must have a 2 KB row (11 bit x 11 bit) refresh configuration. Any 16 MB SIMMs with a 4 KB row (10 bit x 12 bit) refresh configuration are not compatible with this printer.





Color LaserWriter 12/600 PS

The Color LaserWriter 12/600 PS controller board has 8 MB of soldered DRAM and is expandable to 40 MB.

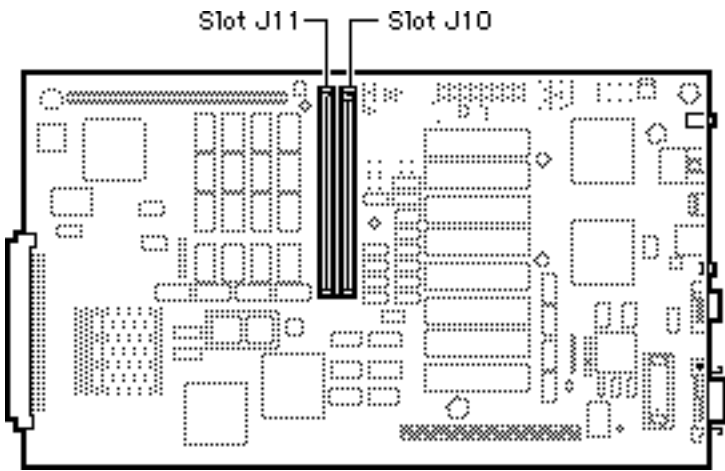

DRAM Configurations		
Total Memory	Install in Slot J10	Install in Slot J11
8 MB	Empty	Empty
12 MB	4 MB	Empty
13 MB	4 MB	1 MB
16 MB	4 MB	4 MB
24 MB	16 MB	Empty
25 MB	16 MB	1 MB
28 MB	16 MB	4 MB
40 MB	16 MB	16 MB

Memory Information	
DRAM Speed	60 ns
SIMM Type	72-pin
Soldered DRAM	8 MB
Expansion Sockets	2
Supported Sizes in MB	256, 1, 4
Maximum DRAM	40 MB

Note: If you install SIMMs of different capacities, install the larger SIMM in slot J10.





LaserWriter 12/640 PS

The LaserWriter 12/640 PS controller board has no soldered DRAM but ships with one 4 MB DRAM SIMM. You can expand the memory to a total of 64 MB.

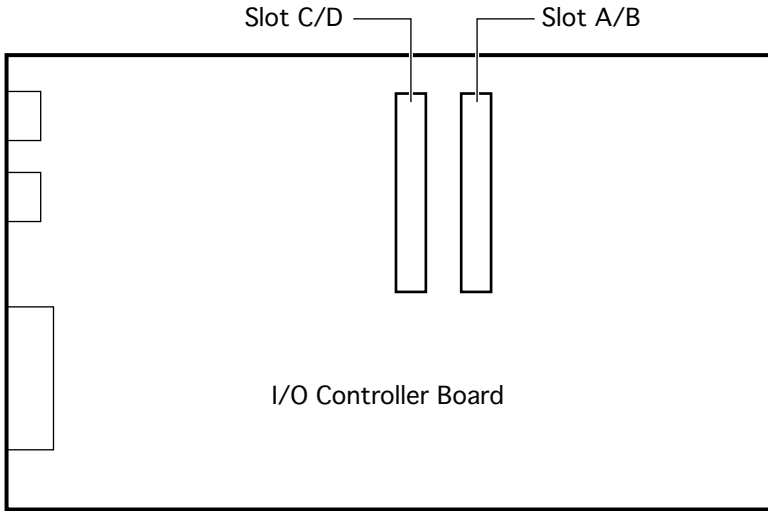

DRAM Configurations		
Total DRAM	Bank C/D	Bank A/B
4 MB	Empty	4 MB
8 MB	4 MB	4 MB
8 MB	Empty	8 MB
12 MB	4 MB	8 MB
12 MB	8 MB	4 MB
16 MB	8 MB	8 MB
16 MB	0 MB	16 MB
20 MB	4 MB	16 MB
24 MB	8 MB	16 MB
32 MB	16MB	16 MB
32 MB	Empty	32 MB
36 MB	4 MB	32 MB
40 MB	8 MB	32 MB
48 MB	16 MB	32 MB
48 MB	32 MB	16 MB
64 MB	32 MB	32 MB

Memory Information	
DRAM Speed	80 ns
SIMM Type	72-pin
Soldered DRAM	None
Expansion Sockets	2
Supported Sizes in MB	4, 8, 16, 32
Maximum RAM	64 MB

Note: To use the duplex printing option OR to turn on PhotoGrade, you need a minimum of 12 MB of DRAM. To use both options at the same time, you need a minimum of 20 MB of DRAM (or 24 MB if using legal size paper).





LaserWriter Select 300

The LaserWriter Select 300 comes with 512K of RAM soldered to the logic board. Using a single 1 MB SIMM or a single 4 MB SIMM, memory can be upgraded to 1.5 MB or 4.5 MB.

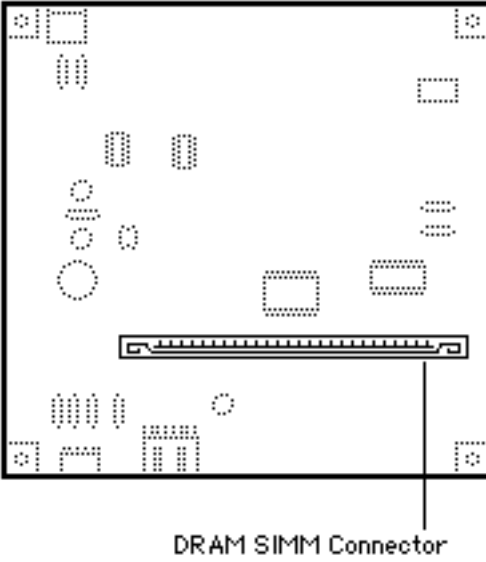

DRAM Configurations	
1.5 MB	Install one 1 MB SIMM.
4.5 MB	Install one 4 MB SIMM.

Memory Information	
DRAM Speed	80 ns
SIMM Type	30-pin
Soldered DRAM	512K
Expansion Sockets	1
Supported Sizes in MB	1, 4
Maximum DRAM	4.5 MB





LaserWriter Select 310

The LaserWriter Select 310 comes with 1.5 MB of DRAM soldered to the logic board. Using a single 4 MB SIMM, memory can be upgraded to 5.5 MB.

DRAM SIMM Connector

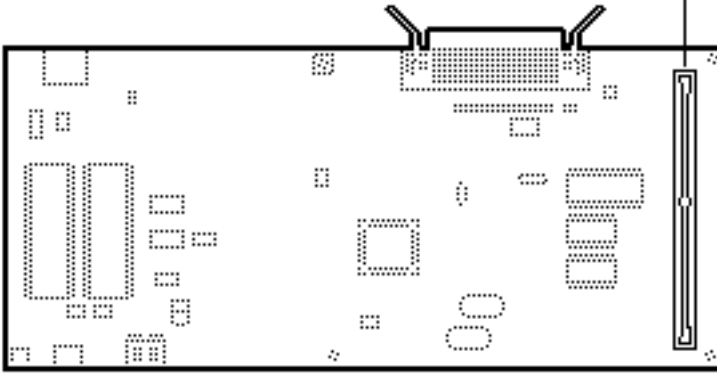

DRAM Configurations	
2.5 MB	Install one 1 MB SIMM.
5.5 MB	Install one 4 MB SIMM.

Memory Information	
DRAM Speed	100 ns
SIMM Type	72-pin
Soldered DRAM	1.5 MB
Expansion Sockets	1
Supported Sizes in MB	1, 4
Maximum DRAM	5.5 MB





LaserWriter Select 360

The LaserWriter Select 360 comes with 7 MB of DRAM, 3 MB of which is soldered to the logic board. You can upgrade to a total of 16 MB by installing a single 16 MB SIMM, in which case the 3 MB of soldered DRAM is disabled.

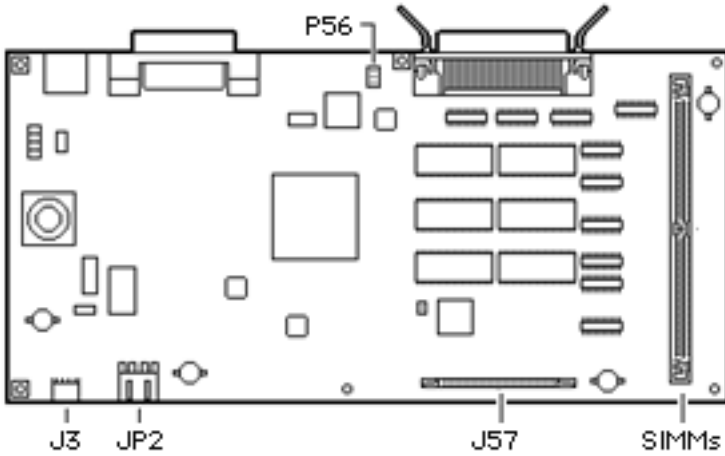

DRAM Configurations	
7 MB	Install one 4 MB SIMM.
16 MB	Install one 16 MB SIMM.

Memory Information	
DRAM Speed	80 ns
SIMM Type	72-pin, 2K refresh
Soldered DRAM	3 MB
Expansion Sockets	1
Supported Sizes in MB	4, 16
Maximum DRAM	16 MB





LaserWriter 8500

The LaserWriter 8500 comes with 16 MB of RAM soldered onto the I/O controller board. There is one SIMM slot for installing additional RAM.

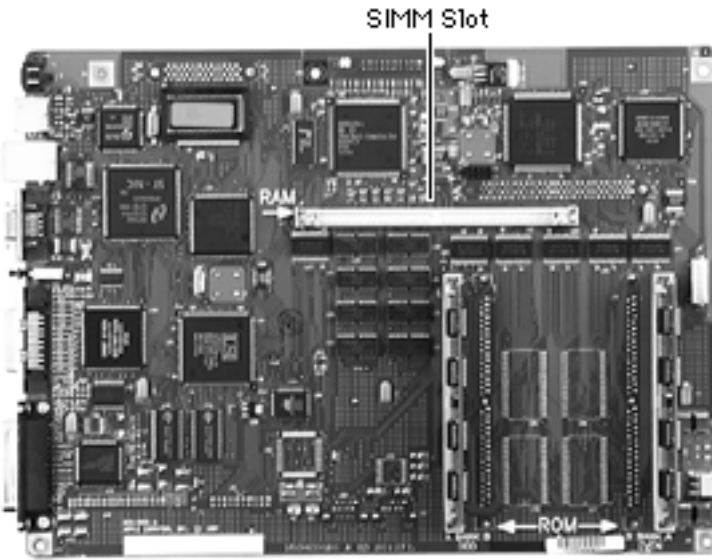

DRAM Configurations	
20 MB	Install one 4 MB SIMM.
24 MB	Install one 8 MB SIMM.
32 MB	Install one 16 MB SIMM.
48 MB	Install one 32 MB SIMM.

Memory Information	
DRAM Speed	70 ns
SIMM Type	72-pin
Soldered DRAM	16 MB
Expansion Sockets	1
Supported Sizes in MB	4, 8, 16, 32
Maximum DRAM	48 MB

Note: To use duplex printing and PhotoGrade features at the same time requires 20 MB minimum.

Note: The 16 MB SIMMs must have a 2 KB row (11 bit x 11 bit) refresh configuration. Any 16 MB SIMMs with a 4 KB row (10 bit x 12 bit) refresh configuration are not compatible with this printer.





PC/DOS Compatible Cards



DOS Compatibility Card

The DOS Compatibility Card has no DRAM soldered onto the card.

You can expand the amount of memory to a total of 32 MB by installing a DRAM SIMM on the card.



DRAM Configurations	
0 MB	The DOS Compatibility Card comes with no installed DRAM.
Up to 32 MB	Use 4, 8, 16, or 32 MB 72-pin SIMM.

Note: This computer does not have any main memory soldered to the logic board. If no DRAM SIMM is installed, the card automatically shares memory with the logic board. The amount of memory allocated to the DOS Compatibility Card is set using the PC Setup control panel.

Memory Information	
DRAM Speed	80 ns
SIMM Type	72-pin, non-composite
Soldered DRAM	None
Number of SIMM Slots	1
Supported Sizes in MB	4, 8, 16, 32
Maximum DRAM	32 MB
Virtual Memory	(See Note)
Soldered Video RAM	512K
Number of Video RAM Slots	none

Virtual Memory Note: Apple recommends you turn off Apple or third-party virtual memory when using this card.





7-Inch 100 MHz PC Compatibility Card

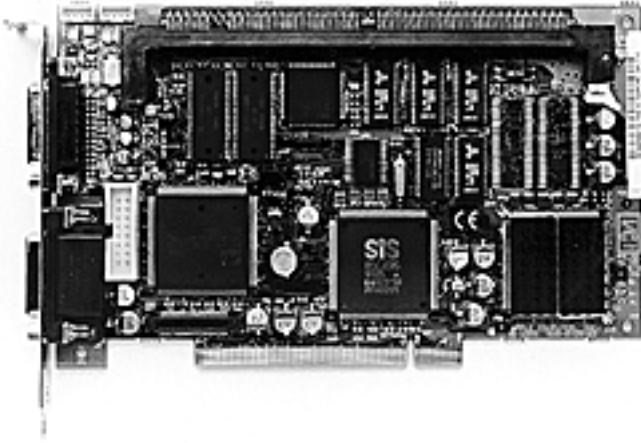

The 7-Inch PC Compatibility Card has no memory soldered on to the card, but it has one expansion slot that comes populated with a 8 MB DRAM DIMM. You can expand the amount of memory to a total of 64 MB by installing 168-pin fast-paged mode DRAM DIMMs.

This card comes with a 586 100 MHz processor with FPU and 128K level 2 cache.

DRAM Configurations	
8 MB	The 7-Inch PC Compatibility Card has 8 MB of installed DRAM.
Up to 64 MB	Use 8, 16, 32 or 64 MB 168-pin DIMM.

Note: To upgrade to more than 8 MB of DRAM, you must remove the original 8 MB of memory that comes installed on the card.

Note: This card does not have any soldered-on memory. As this card is not capable of sharing memory with the logic board, a DRAM DIMM must be installed for the card to operate.

Note: The 7-Inch PC Compatibility Card comes with 1 MB of built-in Video DRAM. The Video DRAM cannot be upgraded.

IMPORTANT: The 7-Inch PC Compatibility Card does **not** support EDO or asymmetrical DRAM DIMMs. DIMMs purchased from Apple are 2K refresh rate, so you can safely use them with the 7-Inch PC Compatibility Card.

Memory Information	
DRAM Speed	60 ns
DIMM Type	168-pin, 64-bit-wide, 2K refresh, fast-paged mode
Soldered DRAM	None
Number of DIMM Slots	1
Supported Sizes in MB	8, 16, 32, 64
Maximum DRAM	64 MB
Virtual Memory	(See Note)
Soldered Video DRAM	1 MB
Number of Video DRAM Slots	None

Virtual Memory Note: Apple recommends you turn off Apple or third-party virtual memory when using this card.





12-Inch 100 MHz PC Compatibility Card

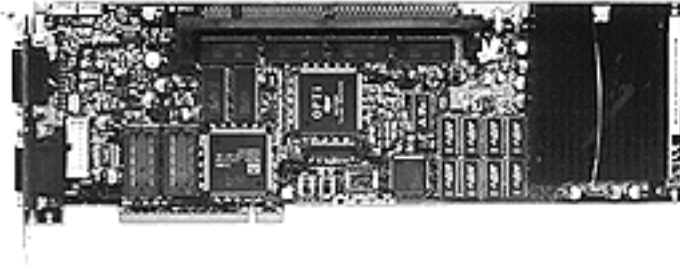

The 12-Inch PC Compatibility Card comes with 8 MB of memory soldered on to the card and one DRAM expansion slot. You can expand the amount of memory to a total of 72 MB by installing a 60 ns, 168-pin, fast-paged mode DRAM DIMM in the expansion slot.

DRAM Configurations	
8 MB	The 12-Inch PC Compatibility Card has 8 MB of soldered-on DRAM.
Up to 72 MB	Use 8, 16, 32 or 64 MB 168-pin DIMM.

Note: If you are adding a 32 MB or 64 MB DIMM to the 12-Inch PC Compatibility Card and you are using PC Setup Version 1.5 or 1.5.1, then you need to install the PC Setup DIMM Patch from one of the Apple Online Software Updates areas. Later versions of PC Setup have the DIMM patch incorporated into them.

IMPORTANT: The 12-Inch PC Compatibility Card does **not** support EDO or asymmetrical DRAM DIMMs. DIMMs purchased from Apple are 2K refresh rate, so you can safely use them with the 12-Inch PC Card.

Virtual Memory Note: Apple recommends you turn off Apple or third-party virtual memory when using this card.

Memory Information	
DRAM Speed	60 ns
DIMM Type	168-pin, 64-bit-wide, 2K or 4K refresh, fast-paged mode
Soldered DRAM	8 MB
Number of DIMM Slots	1
Supported Sizes in MB	8, 16, 32, 64
Maximum DRAM	72 MB
Virtual Memory	(See Note)
Soldered Video DRAM	1 MB
Number of Video DRAM Slots	2

Note: This card comes with 1 MB of built-in Video DRAM. You can increase the video DRAM to 2 MB by installing 5V, 40-pin, 60 ns, 256K x 16, standard fast-page mode SOJ package DRAM devices in the expansion slots provided, but both slots must be populated.





12-Inch 166-P PC Compatibility Card

The 12-Inch 166-P PC Compatibility Card comes with 16 MB of memory soldered on to the card and one DRAM expansion slot. You can expand the amount of memory to a total of 80 MB by installing a 60 ns, 168-pin, fast-paged mode DRAM DIMM in the expansion slot.

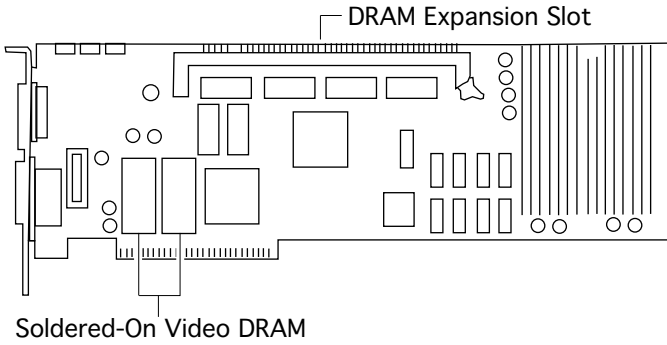

DRAM Configurations	
16 MB	The 12-Inch 166-P PC Compatibility Card has 16 MB of soldered-on DRAM.
Up to 80 MB	Use 8, 16, 32 or 64 MB 168-pin DIMM.

Virtual Memory Note: Apple recommends you turn off Apple or third-party virtual memory when using this card.

Memory Information	
DRAM Speed	60 ns
DIMM Type	168-pin, 64-bit-wide, 2K or 4K refresh, fast-paged mode
Soldered DRAM	16 MB
Number of DIMM Slots	1
Supported Sizes in MB	8, 16, 32, 64
Maximum DRAM	80 MB
Virtual Memory	(See Note)
Soldered Video DRAM	2 MB
Number of Video DRAM Slots	None

Memory Information	
DRAM Speed	60 ns





12-Inch 166-C PC Compatibility Card

The 12-Inch 166-C PC Compatibility Card comes with 16 MB of memory soldered on to the card and one DRAM expansion slot. You can expand the amount of memory to a total of 80 MB by installing a 60 ns, 168-pin, fast-paged mode DRAM DIMM in the expansion slot.

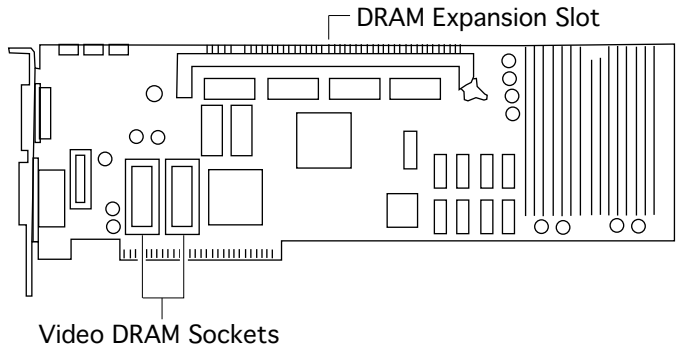

DRAM Configurations	
16 MB	The 12-Inch PC Compatibility Card has 16 MB of soldered-on DRAM.
Up to 80 MB	Use 8, 16, 32 or 64 MB 168-pin DIMM.

Virtual Memory Note: Apple recommends you turn off Apple or third-party virtual memory when using this card.

Memory Information	
DIMM Type	168-pin, 64-bit-wide, 2K or 4K refresh, fast-page mode
Soldered DRAM	16 MB
Number of DIMM Slots	1
Supported Sizes in MB	8, 16, 32, 64
Maximum DRAM	80 MB
Virtual Memory	(See Note)
Soldered Video DRAM	1 MB
Number of Video DRAM Slots	2

Note: This card comes with 1 MB video DRAM, expandable to 2 MB.





Video Cards



Display Card 4•8

The Display Card 4•8 has 512K of soldered VRAM.

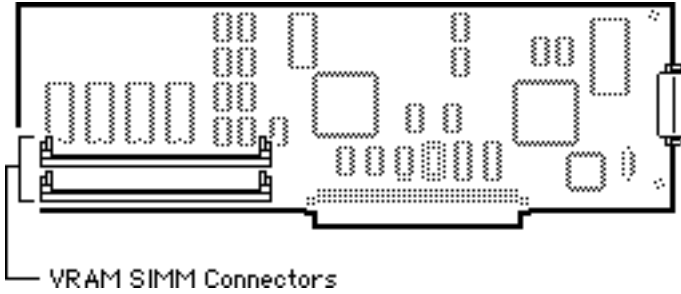

VRAM Configurations	
512K	The Display Card 4•8 has 512K of soldered VRAM.
1 MB	Install two 256K SIMMs.

VRAM Memory Information	
VRAM Speed	100 ns
VRAM SIMM Type	64-pin
Soldered VRAM	512K
Number of VRAM Slots	2





Display Card 8•24GC

DRAM SIMM Connectors

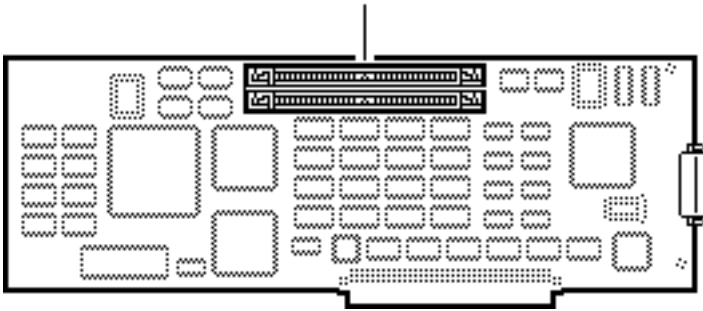

VRAM Configurations	
2 MB	Install two 1 MB SIMMs.

VRAM Memory Information	
VRAM Speed	100 ns
VRAM SIMM Type	64-pin
Soldered VRAM	none
Number of VRAM Slots	2





Power Macintosh 2 MB Video Card

The Power Macintosh 2 MB Video Card has 1 MB of soldered VRAM.

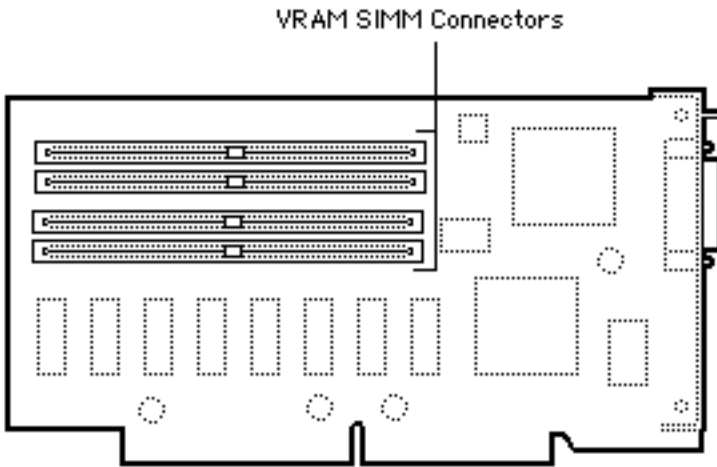

VRAM Configurations	
1 MB	The Power Macintosh 2 MB Video Card has 1 MB of soldered VRAM.
2 MB	Install four 256K VRAM SIMMs.

VRAM Memory Information	
VRAM Speed	80 ns
VRAM SIMM Type	68-pin
Soldered VRAM	1 MB
Number of VRAM Slots	4





Power Macintosh 4 MB Video Card

The Power Macintosh 4 MB Video Card has 2 MB of soldered VRAM.

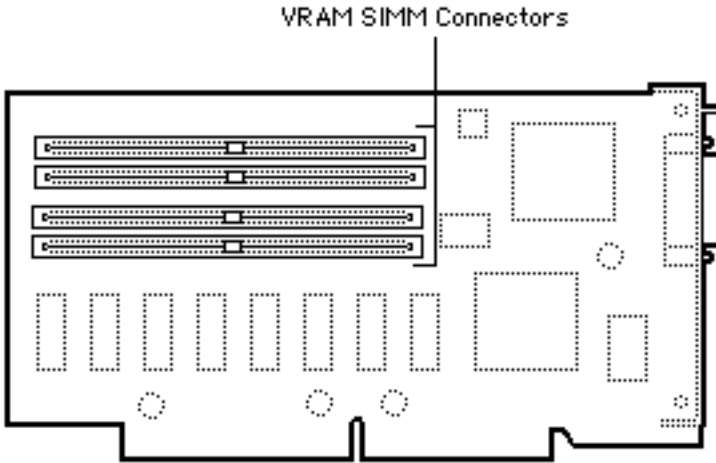

VRAM Configurations	
2 MB	The Power Macintosh 4 MB Video Card has 2 MB of soldered VRAM.
4 MB	Install four 512K VRAM SIMMs.

VRAM Memory Information	
VRAM Speed	80 ns
VRAM SIMM Type	68-pin
Soldered VRAM	2 MB
Number of VRAM Slots	4





Miscellaneous



About Apple Memory Guide

April 1998

Welcome to the Apple Memory Guide (AMG). The April 1998 version of this document includes information on the new Power Macintosh G3 All-In-One computer.





Composite SIMMs

Apple has identified problems using composite SIMMs on selected Macintosh computer models. Because of the nature of these problems, Apple does not recommend the use of composite SIMMs in any Macintosh computer.

Definition

A *composite* SIMM is defined as a SIMM made up of banks of many smaller DRAM devices, with additional bank-controlling circuitry and perhaps buffers for the address and control signals. A *noncomposite* SIMM, on the other hand, is organized as a single bank of devices. As an example, a 16 MB composite SIMM would be made up of thirty-two 4 Mbit DRAM chips, along with the additional circuitry to control the banks. Conversely, a noncomposite 16 MB SIMM would be made up of eight 16 Mbit chips only. Composite SIMMs are made up of more commonly available and less-expensive parts, hence the attraction.

Problems

Composite SIMMs pose timing and electrical problems in some Macintosh computers, particularly those optimized for maximum DRAM performance (such as the Macintosh Quadra 610, Macintosh Quadra 650, Macintosh Quadra 800, and the Macintosh Quadra 900 series and all Power Macintosh computers).

Composite SIMMs have a larger number of DRAM devices than the SIMMs with which Apple has tested. The extra components result in larger peak currents to the devices during read/write accesses and refresh. These larger peak currents subsequently result in added stress to the power system and an overall increase in system noise. The increase in system noise has caused problems on some systems (such as the Quadra 900 and Quadra 950).

The additional circuitry added to composite SIMMs appears to add a slight amount of overhead to the timing of memory accesses. The Macintosh Quadra 800 has very strict timing guidelines (it requires 60 ns DRAM), and is particularly sensitive to this potential problem. These problems may not occur until additional SIMMs are added (for example, two composite SIMMs may work, but four composite SIMMs may cause random failures, or the system may not boot). In addition, the larger physical dimensions of the composite SIMMs may make proper installation difficult or impossible.





May Work Under Some Conditions, But...

Composite SIMMs may work under some conditions, but users may experience random failures (such as startup failures, system errors, or other strange crashes). The errors can vary with different SIMMs, SIMM configurations, and vendors.

In addition, process variations in chips used in various Macintosh computers (such as memory controllers) can mean one CPU might act a little differently than the same model manufactured at a different time. It's even possible to see minute variations caused by temperature and supply voltages.

Conclusion

Apple does not support composite SIMMs, nor does it guarantee that they will work in any Macintosh (because of the electrical and timing problems identified with selected Macintosh computers). Apple recommends the use of noncomposite SIMMs because they are less likely to have problems similar to those described here. While presently expensive, it is expected that the cost of 16 Mbit chip SIMMs will decrease.





DIMM Information

Dual In-line Memory Modules (DIMMs) provide a wider data path than Single In-line Memory Modules (SIMMs). DIMMs are “wider” than SIMMs in the amount of data they can carry.

The Power Macintosh 7200, 7500, 8500, and 9500 series computers use 168-pin, 70 ns or faster DIMMs, which are 64-bit wide. It takes one DIMM to meet the 64-bit wide data bus requirement. The Power Macintosh 7500, 8500, and 9500 series computers also support memory interleaving when DIMMs are installed in pairs. The Power Macintosh 7200 series computers do not support memory interleaving and can be installed one DIMM at a time.

Refresh Rate

DRAM devices require a power source to maintain their data integrity. However, DRAM is not supplied with power 100% of the time. Instead, power is resupplied (refreshed) on a regular, timed interval. DRAM devices are organized into two-dimensional arrays of rows and columns. A single row is refreshed at a time. The refresh rate refers to the number of refresh cycles required to refresh all sections of the memory array, and is equal to the number of rows.





Performa to Macintosh Table

The table below will help you identify which Performa computer is equivalent to the Macintosh models.

Performa	Comparable Macintosh	Processor	Intro Date	Notes
200	Classic II 4/80	68030@16MHz	9/15/92	1
400	LC II 4/80/512	68030@16MHz	9/15/92	1
405	LC II 4/80/256	68030@16MHz	4/15/93	1
410	LC II 4/80/512	68030@16MHz	10/21/93	1
430	LC II 4/120/512	68030@16MHz	4/15/93	1
450	LC III 4/120/512	68030@25MHz	4/15/93	2
460	LC III 4/120/512	68030@33MHz	10/21/93	2
466	LC III 4/160/512	68030@33MHz	10/21/93	2
467	LC III 4/120/512	68030@33MHz	10/21/93	2
475	LC 475 4/160/512	68LC040@25MHz	10/21/93	3
476	LC 475 4/230/512	68LC040@25MHz	10/21/93	3
520	LC 520	68030@33MHz	6/15/93	2
550	LC 550 5/160/512, CD	68030@33MHz	10/21/93	2
560	LC 550 CD 5/160/768	68030@33MHz	10/21/93	2
575	LC 575 CD 5/250/1MB	68LC040@33MHz	4/26/94	3
577	LC 575 CD 5/320/1MB	68LC040@33MHz	4/26/94	3
578	LC 575 CD 8/320/1MB	68LC040@33MHz	4/26/94	3
600	Ilvx 5/120/512	68030@32MHz	9/15/92	2, 4
600CD	Ilvx 5/120/512, CD	68030@32MHz	9/15/92	2, 4
63x	LC 630	68LC040@66MHz	7/18/94	3, 5
640DOS	LC 630 DOS	68LC040@66MHz	5/5/95	3
52xx	Macintosh 5200/75 LC	PowerPC 603	5/5/95	6
611x	Power Macintosh 6100/60	PowerPC 601	10/3/94	7
62xx	Power Macintosh 6200/75	PowerPC 603	7/5/95	8

Note:

- 1 FPU upgrade by way of third party PDS card.
- 2 Install M6775LL/A (FPU) in socket.
- 3 Replace 68LC040 w/68RC040 Apple does not recommend or support replacing the CPU.
- 4 No RAM cache.
- 5 The Performa 630 series includes the Performa 635, 636, 637, and 638.
- 6 The Performa 52xx series includes the Performa 5200, 5210, 5215, and 5220.
- 7 The Performa 611x series includes the Performa 6110, 6112, 6115, 6117, and 6118.
- 8 The Performa 62xx series includes the Performa 6200, 6214CD, 6216, 6218, 6220, and 6230.





Additional Procedures



SIMM Removal Tool

Note: The Apple SIMM removal tool is a diagnostic tool for service providers and, therefore, not available to the general public. AMP Inc. is the manufacturer of the SIMM tool; the AMP part number for the tool is 821987-02.

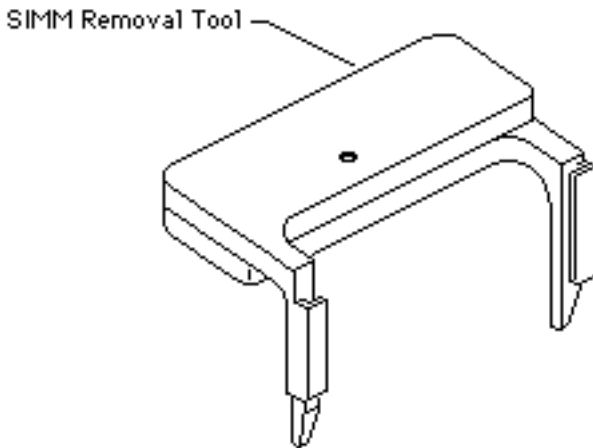

Use the SIMM removal tool to remove SIMMs from the SIMM sockets on any of the Early Macintosh or LaserWriter logic boards.

Using the removal tool reduces the possibility of breaking the holding tabs on the SIMM sockets. The tool works two ways—vertically or at an angle.

Note: The tool does not work with Quadra VRAM SIMMs.



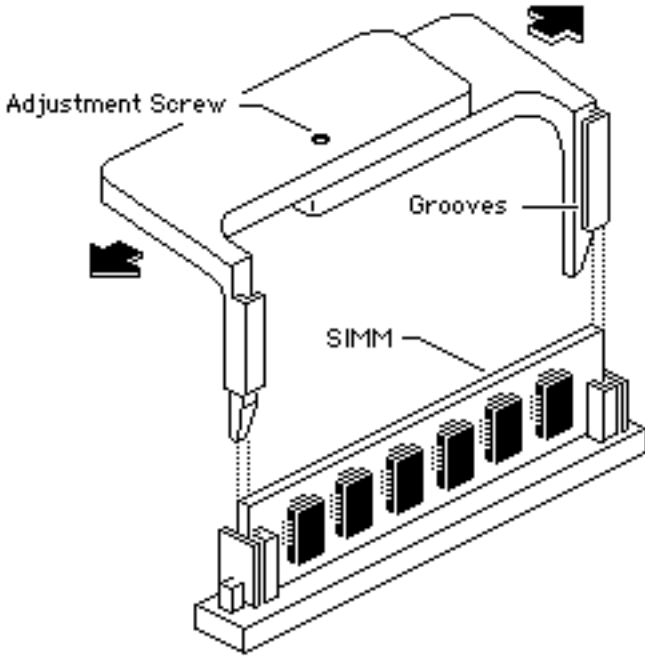

Note: You must adjust the tool to the SIMM you are removing.

Loosen the adjustment screw on the bottom of the tool so that the two parts of the tool can move.

Adjust the tool from side to side until the grooves fit over the edges of the SIMM you are removing.

Tighten the adjustment screw.



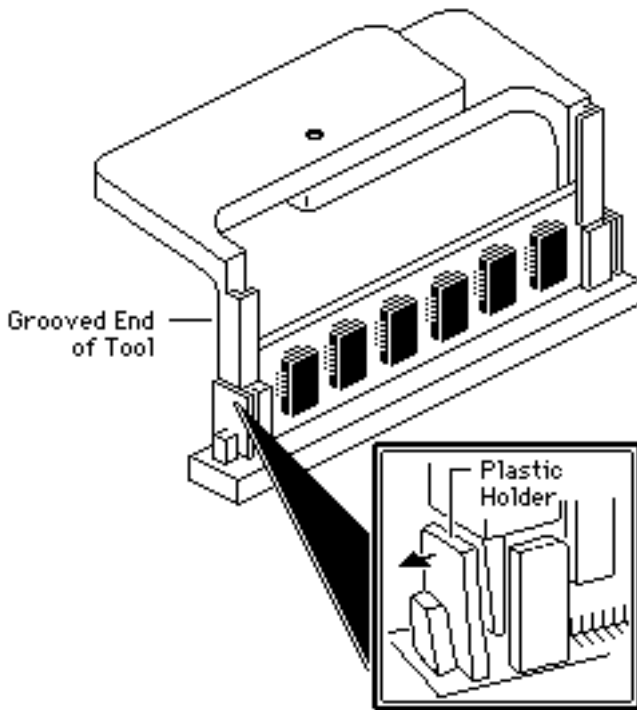

Vertical SIMM Removal

Place the grooved ends of the tool over the edges of the SIMM.

Gently press the tool down onto the board.

Note: The edges of the tool should push the plastic holders slightly to the side.





Gently rotate the tool backward until the SIMM becomes loose.

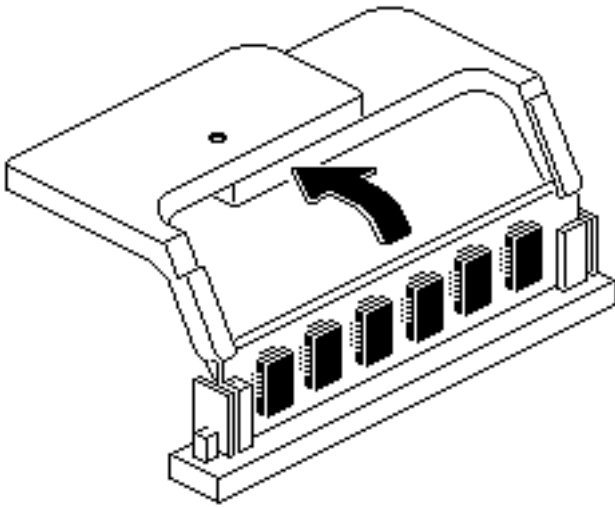



Pull up and remove the SIMM from the socket.

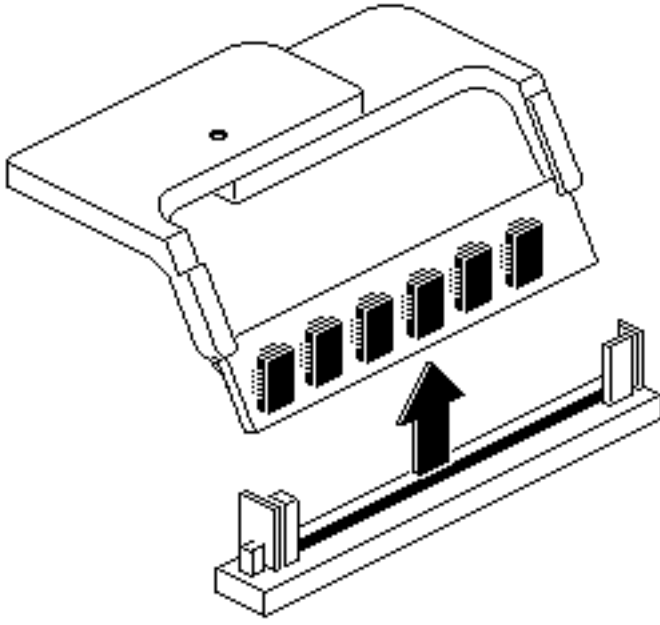



Angle SIMM Removal

Place the grooved ends of the tool over the edges of the SIMM.

Gently slide the leading edge of the tool over the protruding alignment button and spread open the SIMM socket tabs.

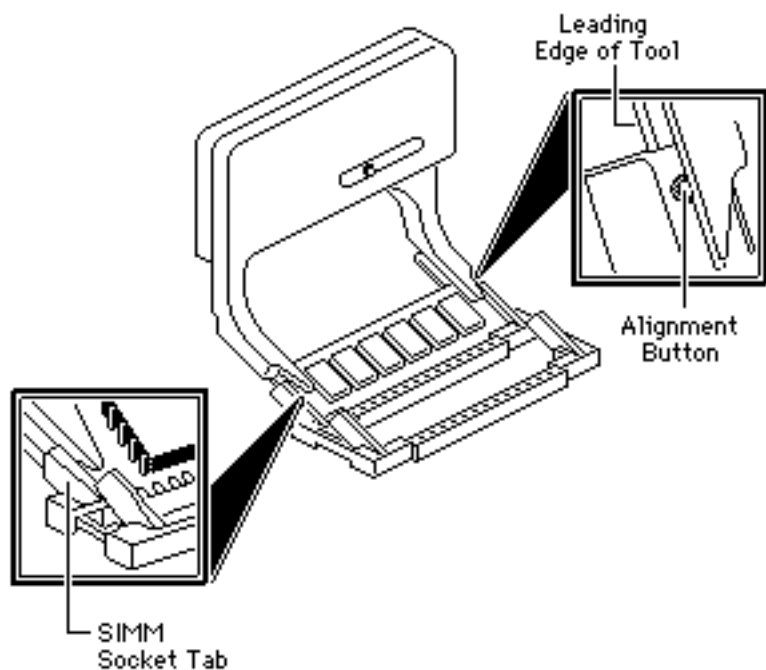



Gently rotate the tool backward until the SIMM becomes loose.





Pull up and remove the SIMM from the socket.

